

Artista Gallery, Inc. Presents:

NewRetroDining.com

Made in USA - Retro 50's Furniture

Classic Diner Catalog



**Authentic
High Quality**

**Proudly Crafted in the USA Residential and
Commercial Retro Furniture**

Phone (478) 320-2502 ♦ Fax (404) 420-2890

www.NewRetroDining.com

Artista Gallery, Inc. ♦ 1004 Briarcliff Rd. ♦ Warner Robins, GA 31088

Rev 01JAN16

Table Of Contents

Chairs & Stools

Innovations

INN - 2100.....	15
INN - 2110 BS.....	15
600 - INN - 2120 BS.....	15
1800 - INN - 2120 BS.....	15
INN - 2200.....	16
INN - 2210 BS.....	16
600 - INN - 2220 BS.....	16
1800 - INN - 2220 BS.....	16
INN - 2300.....	17
INN - 2310 BS.....	17
600 - INN - 2320 BS.....	17
1800 - INN - 2320 BS.....	17
INN - 2400.....	18
INN - 2410 BS.....	18
600 - INN - 2420 BS.....	18
1800 - INN - 2420 BS.....	18
INN - 2500.....	19
INN - 2510 BS.....	19
600 - INN - 2520 BS.....	19
1800 - INN - 2520 BS.....	19
INN - 2600.....	20
INN - 2610 BS.....	20
600 - INN - 2620 BS.....	20
1800 - INN - 2620 BS.....	20

Cafe

ADR - 200.....	21
ADR - 1200 BS.....	21
BRD - 1000 BS.....	21
BRD - 1100 BS.....	21
HPN - 100.....	22
HPN - 1100 BS.....	22
HPN - 1150 BS.....	22
LKE - 100.....	22
MAD - 100.....	23
MAD - 1100 BS.....	23
MKT - 100.....	23
MKT - 1100 BS.....	23
OSG - 100.....	24
OSG - 1100 BS.....	24
OSW - 100.....	24
PRK - 100.....	24
1155.....	25
1155 BS.....	25

Manhattan

MAN - 100.....	26
MAN - 1100 BS.....	26
MAN - 120.....	27
MAN - 140.....	27
MAN - 1160 BS.....	27
MAN - 220.....	27
MAN - 1220 BS.....	28
MAN - 250 PS4.....	28
MAN - 250 PS3.....	28
MAN - 1250 BS.....	28
MAN - 300 FP.....	29
MAN - 400 PS4.....	29

Woodland

WLS - 100.....	30
WLS - 1000 BS.....	30
WLS - 130.....	30
WLS - 1130 BS.....	30
WLS - 135.....	31
WLS - 1135 BS.....	31
WLS - 145.....	31
WLS - 1145 BS.....	31
WLS - 180.....	32
WLS - 1180 BS.....	32
WLS - 200.....	33
WLS - 1200 BS.....	33
WLS - 300.....	33
WLS - 1300 BS.....	33
WLS - 1310 BS.....	34

Legends

LSC - 250.....	35
LSC - 1250 BS.....	35
600 - LSC - 250 BS.....	35
1800 - LSC - 250 BS.....	35
LSC - 350.....	36
LSC - 1350 BS.....	36
600 - LSC - 350 BS.....	36
1800 - LSC - 350 BS.....	36
LSC - 450.....	37
LSC - 1450 BS.....	37
600 - LSC - 450 BS.....	37
1800 - LSC - 450 BS.....	37
LSC - 475.....	38
LSC - 1475 BS.....	38
600 - LSC - 475 BS.....	38

1800 - LSC - 475 BS.....	38
LSC - 501.....	39
LSC - 1501 BS.....	39
600 - LSC - 501 BS.....	39
1800 - LSC - 501 BS.....	39
LSC - 550.....	40
LSC - 1550 BS.....	40
600 - LSC - 550 BS.....	40
1800 - LSC - 550 BS.....	40
LSC - 575.....	41
LSC - 1575 BS.....	41
600 - LSC - 575 BS.....	41
1800 - LSC - 575 BS.....	41
LSC - 600.....	42
LSC - 1600 BS.....	42
600 - LSC - 600 BS.....	42
1800 - LSC - 600 BS.....	42
LSC - 650.....	43
LSC - 1650 BS.....	43
600 - LSC - 650 BS.....	43
1800 - LSC - 650 BS.....	43
LSC - 750.....	44
LSC - 1750 BS.....	44
600 - LSC - 750 BS.....	44
1800 - LSC - 750 BS.....	44

Oxford

OX - 10.....	45
OX - 110 BS.....	45
600 - OX - 10 BS.....	45
1800 - OX - 10 BS.....	45
OX - 20.....	46
OX - 120 BS.....	46
600 - OX - 20 BS.....	46
1800 - OX - 20 BS.....	46
OX - 30.....	47
OX - 130 BS.....	47
600 - OX - 30 BS.....	47
1800 - OX - 30 BS.....	47
OX - 40.....	48
OX - 140 BS.....	48
600 - OX - 40 BS.....	48
1800 - OX - 40 BS.....	48
OX - 50.....	49
OX - 150 BS.....	49
600 - OX - 50 BS.....	49
1800 - OX - 50 BS.....	49
OX - 60.....	50

OX - 160 BS.....	50
600 - OX - 60 BS.....	50
1800 - OX - 60 BS.....	50

Omni & Spectrum

SCB - PS.....	51
CBBS - PS.....	51
DS - PS.....	51
DSBS - PS.....	51
FB - PS.....	52
SFB - BS.....	52
FBBS - PS.....	52
HG - PS.....	52
HGBS - PS.....	53
HP - PS.....	53
HPBS - PS.....	53
IT - PS.....	53
ITBS - PS.....	54
MR - BS.....	54
SMR - PS.....	54
MRBS - PS.....	54
PB - PS.....	55
PBBS - PS.....	55
RB - PS.....	55
RBBS - PS.....	55
SSB - PS.....	56
SBBS - PS.....	56
UFB - PS.....	56
UFBBS - PS.....	56
UHP - PS.....	57
UHPBS - PS.....	57
USB - PS.....	57
USBBS - PS.....	57
BLBS - PS.....	58

Stacker Chair

RO - 150 SH.....	59
RO - 200 WF.....	59
X - 6.....	59
X - 10.....	59
X - 18.....	60
X - 18 LS.....	60
X - 18 LSIB.....	60
X - 23.....	61
X - 23 AR.....	61
X - 24 Econo.....	61
X - 25.....	62
X - 25 WF.....	62

X - 25 ISDT.....	62
X - 25 SHCB.....	62
X - 37.....	63
X - 37 LS.....	63
X - 37 WF.....	63
X - 37 ISCB.....	63
X - 38.....	64
X - 38 LS.....	64
X - 38 WF.....	64
X - 38 LSDT.....	64
X - 43.....	65
X - 43 WF.....	65
X - 43 WFHR.....	65
Extra Chair Features.....	65
X - 45.....	66
X - 45 LS.....	66
X - 45 SH.....	66
X - 45 WFCB.....	66

Faculty

907 - 242 WF.....	67
S - 3 Tilting.....	67
S - 4 Non-Tilting.....	67

Parlor

X - 52.....	68
X - 52 BS.....	68
X - 53.....	68
X - 53 BS.....	68
X - 54.....	69
X - 54 BS.....	69
X - 55.....	69
X - 55 BS.....	69

Classic Chairs & Stools

921.....	70
921 "V".....	70
921 DT.....	70
921 BS.....	70
921 ELSH.....	71
921 ELSH - BS.....	71
921 MBWF.....	71
921 MBWF - BS.....	71
921 HB.....	72
921 HB - BS.....	72
921 HBSH.....	72
921 HBWF - BS.....	72

921 HBMBSH.....	73
921 HBMBWF - BS.....	73
921 BB.....	73
934.....	73
939 CBWF.....	74

Classic Stools

215 - 46.....	75
215 - 125 R.....	75
215 - 125 RB.....	75
215 - 530.....	75
215 - 531 SH.....	76
215 - 782/49 NS.....	76
215 - 782 RB/49 NSRB.....	76
215 - 921.....	76
250 - 49 NS.....	77
250 - 49 NSRB.....	77
250 - 781/46.....	77
250 - 782.....	77
250 - 782 RB.....	78
250 - 921 BB.....	78
250 - 921 MB.....	78
250 - 921 "V".....	78
264 - 49 NSRB.....	79
264 - 125.....	79
264 - 161.....	79
264 - 530.....	79
264 - 781/46.....	80
264 - 782/49 NS.....	80
264 - 782 RB.....	80
264 - 921.....	80
265 - 125 R.....	81
265 - 125 RB.....	81
265 - 214.....	81
265 - 242 WF.....	81
265 - X18 SHIB.....	82
265 - X23.....	82
300 - 49 NS/782.....	83
300 - 49 NSRB/782 RB.....	83
300 - 161.....	83
300 - 531 SH.....	83
300 - 781/46.....	84
300 - 921/530.....	84
300 - 921 "V".....	84
300 - 939 CB.....	84
400 - 49 NS.....	85
400 - 49 NSRB.....	85
400 - 125 R.....	85
400 - 242 WF.....	85

400 - 781/46.....	86
400 - 782.....	86
400 - 782 RBMB.....	86
400 - 921 HB.....	86
500 - 46.....	87
500 - 125.....	87
500 - 161.....	87
500 - 242 WF.....	87
500 - 781.....	88
500 - 782.....	88
500 - 782 RB.....	88
500 - 921.....	88
751 Econo.....	89
752 Econo.....	89
1500 - 46.....	90
1500 - 161.....	90
1500 - 530.....	90
1500 - 781.....	90
1500 - 782.....	91
1500 - 782 RB.....	91
1500 - 921.....	91
1500 - 939 CB.....	91
1700 - 46.....	92
1700 - 161.....	92
1700 - 781.....	92
1700 - 782.....	92
1700 - 782 RB - EL.....	93
1700 - 921.....	93
1700 - 921 "V".....	93
1700 Custom Features.....	93
1500 & 1700 Floor Attachments	94
Footrest	95
Glides	96
Swivels	97

Modular

HP - PS Modular.....	98 - 99
DS - PS Modular.....	98 - 99
FB - PS Modular.....	98 - 99
X - 51 Modular.....	100-101
X - 52 Modular.....	100-101
X - 53 Modular.....	100-101
X - 55 Modular.....	100-101
46 Modular.....	102-103
125 Modular.....	102-103
781 Modular.....	102-103

782 Modular.....	102-103
125 RB Modular.....	104-105
782 RB Modular.....	104-105
921 Modular.....	104-105
939 CBWF Modular.....	104-105
Stool Heads.....	106-107
Cantilevered Counter Stools.....	108
Modular Seating Plan.....	109

Booths

Standard Booth Sizes.....	111
Booth Options.....	112
GY - 1 Gateway Booth.....	113
OZ - 1 Ozark Booth.....	113
SR - 1 Sierra Booth.....	114
HZ - 1 Horizon Booth.....	114
LH - 1 Lockhaven Booth.....	115
LH - 2 - LSB Lockhaven Booth.....	115
SD - 1 Serenade Booth.....	116
SD - 2 Serenade Booth.....	116
GV - 1 Gravois Booth.....	117
GV - 3 Gravois Booth.....	117
FN - 1 Fenton Booth.....	118
FN - 4 - WTC Fenton Booth.....	118
ST - 4300 Streamliner Booth.....	119
OD - 6000 Odyssey Booth.....	119
NW - 5 - CT - UCS Norwood Booth	120
NW - 5 - UCS - WSB Norwood Booth	120
BA - 4300 Bel-Air Booth.....	121
V - 4300 Vintage Booth.....	121
HW - 4300 Hollywood Booth.....	122
CH - 1 Chevie Booth.....	122
EL - 4300 Elite Booth.....	123
MB - 4300 Malibu Booth.....	123
MD - 1000 Midway Booth.....	124
MD - 3000 Midway Booth.....	124
MD - 4000 Midway Booth.....	124
S - ST Smooth Settee.....	125
S - TT Tufted Settee.....	125
Booth Seating Diagram.....	126

Table Tops

Standard Table Sizes.....	128
BE - 125.....	129
BN - 125.....	130

EWE - 125.....	131
DWW - 125.....	132
DWB - 125.....	132
DWR - 125.....	132
PWE - 125.....	133
PWW - 125.....	133
PWB - 125.....	133
PWR - 125.....	133
UWE - 175.....	134
UWW - 175.....	134
UWB - 175.....	134
UWR - 175.....	134
SWE - 150.....	135
SWB - 150.....	135
BGA - 125.....	136
BGA - 125 Gloss Cracked Ice	137
BGA - 125 Gloss Boomerang	138
BGA - 225.....	139
BGA - 225 Gloss Cracked Ice	140
BGA - 225 Gloss Boomerang	141
SE - 125.....	142
SE - 200.....	143

Table Bases

Bases.....	144
"A" series.....	145
"B" series.....	146
"C" series.....	147-149
"D" series.....	150-151
Flip - Top.....	152
"F" series cantilever.....	153
"G" series cantilever.....	154
"H" series.....	155
"H" Teardrop series.....	155
1800 TB series.....	156
884 Legs.....	156
885 Legs.....	156

Accessories

Chair Caddy.....	158
Chair Dolly.....	158
Decorative Wall Panels.....	158
Hall Costumer.....	159
Booth Costumer.....	159
Acrylic Gallery.....	159

Coca - Cola Series

Dynamic Ribbon Booth.....	161
215 - 125 R CBB.....	161
215 - 782 FT.....	161
250 - 781 CBB.....	161
250 - 921 CBB.....	162
264 - 125 CBB.....	162
264 - 782 FT.....	162
264 - 782 RB CBB.....	162
300 - 921 CBB.....	163
400 - 46 FT.....	163
400 - 49 NS - CBB.....	163
500 - 782 CBB.....	163
752 CBB.....	164
1500 - 49 NSFT - 505.....	164
1700 - 782 CBB.....	164
1800 - X50 CWD.....	164
1800 - X50 CWD - 606.....	165
CBB Head.....	165
FT Head.....	165
Vintage Logo Head.....	165
Coke Diner Set.....	165
921 CBB.....	165
BGA - 125 - 30 CBB Set.....	166
BGA - 125 - 30 - 42 CBB Set.....	166
BGA - 125 - 2442 CBB Set.....	166

Outdoor Series

6' Square Umbrella.....	168
7' Octagonal Umbrella.....	168
41 lb Umbrella Base.....	168
81 lb Umbrella Base.....	168
BRK - 100.....	169
BRK - 100 AR.....	169
BRK - 1100 BS.....	169
Butterfly Base Set.....	169
Pub Base Set.....	169

50's Stocking Program

Fifties Stocking Items.....	170
-----------------------------	-----

What Makes New Retro Dining Products Different?

The majority of furniture New Retro Dining provides is produced and manufactured in the U.S.A. Providing quality furniture crafted with pride by American workers.

Artista Gallery, Inc.

Terms & Conditions (Last updated January 01, 2016)

Thank you for shopping at NewRetroDining.com. Your use of this site is governed by the Terms and Conditions set forth below. By making a purchase or placing an order you signify your acceptance of the conditions set forth below. Please take a moment to read through our terms thoroughly. Artista Gallery, Inc. reserves the right to make changes to this site and the Terms and Conditions at any time without prior notice.

- This agreement supersedes any other verbal, written or printed agreement or any other undertaking relating to any transaction(s) entered into with Artista Gallery, Inc.
- This policy may not be altered or amended in any manner and the buyer by placing an order accepts and agrees to abide by the terms and conditions contained herein.
- Artista Gallery, Inc. reserves the right to modify this site and its Terms and Conditions at any time without prior notice.
- All prices posted on the Artista Gallery, Inc. websites are for mail order only.
- Applicable sales tax is added to orders delivered within the State of Georgia.
- Prior to sale, prices, specifications and availability are subject to change without notice.
- No refunds will be issued for difference in price due to price drop.
- Artista Gallery, Inc. is not responsible for any typographical errors and pictorial representations in our advertisements. Corrections will be made as soon as the mistake comes to our notice.
- Every effort will be made to be accurate. However, Artista Gallery, Inc. will not honor prices inadvertently published.
- Artista Gallery, Inc. shall retain ownership of the goods purchased hereunder until payment from the purchaser has been received in full. Artista Gallery, Inc. shall have the right to demand payment or repossess the goods in the event of the purchaser's bankruptcy, insolvency or other failure to fulfill its payment obligations hereunder. In the event of such failure, the purchaser shall be required to safely and properly store the goods purchased hereunder separately, to identify them as belonging to Artista Gallery, Inc., and to allow us access to the purchaser's premises in order to verify that the goods are stored correctly, and to repossess them.

METHOD OF PAYMENT

Payment may be made to the order of Artista Gallery, Inc. by Money Order, Cashier's Check, Personal Check, Company Check, Master Card, Visa Card, Discover Card, American Express Card or Paypal.

- Full payment is cleared before order(s) are processed and shipped.
- Payment must be made on agreed terms between Artista Gallery, Inc. and purchaser.

RETURNS

No returned merchandise will be accepted by Artista Gallery, Inc. for exchange, credit or repair unless prior written consent is given by us. Unauthorized returns will be refused and returned to the consignee freight collect. Where returns are authorized, Artista Gallery, Inc. will issue a Return Material Authorization (RMA) Form with shipping instructions which must be used with such returns indicating any restocking and/or freight charges that will be billed to the buyer. Restocking charges will range from 25% to 50% of the original purchase price.

STORAGE

Under normal circumstances, if buyer advises at time of placing order that shipment should be made after a specified date, Artista Gallery, Inc. will try to accommodate such requests. If however no specific date was requested, and when the order is ready for shipment, buyer is unable or unwilling to accept delivery, Artista Gallery, Inc. will invoice the buyer as of the scheduled date of shipping, and charge buyer for all handling, transfer and storage costs incurred from the scheduled date until actual shipping date. Where returns are authorized, Artista Gallery, Inc. will issue a Return Material Authorization Form with shipping instructions which must be used with such returns indicating any restocking and/or freight charges that will be billed to the buyer. Restocking charges will range from 25% to 50% of the original purchase price.

ASSEMBLY (Written instruction are provided)

- All chairs, backless stools and booth benches are delivered fully assembled.
- All stools with backs require attaching the seat to the swivel base.
- All tables require attachment of the legs or pedestal base to the table tops.

ORDER CHANGES & CANCELLATIONS

Due to the custom nature of our products, Artista must specify purchase materials and individually assemble to meet the unique and demanding specifications designated in each purchase order. Therefore, once Artista accepts and acknowledges an order, it is fully binding and is not subject to cancellation or change by the buyer.

This does not mean that it is never possible to cancel or change an order, however, the request must be in writing, approved and acknowledged by Artista and may require charges for labor, materials, and/or other expenses we have incurred. (*Minimum charge per change order: \$66.67 list*). *Order will in some cases require updated ship date.*

PREVIOUS ORDER MATCHING

If your order is to match a previous order, it must be clearly stated on your order, with reference made to our original invoice or acknowledgment number and date. **If available, please supply a copy of the original invoice.** Artista is not responsible to supply materials such as laminate, vinyl, fabrics or other items that may be discontinued.

Finishes (*Fabrics, vinyl, stains, and paints*) may change over a period of time and it is recommended that the buyer submit a sample from the original order when possible to assure the best possible match. When a special wood finish is requested, **Artista** will attempt to match as closely as possible, but cannot assume responsibility for variations resulting from application of color finishes on various woods. Artista in some instances may request the buyer return a signed approval prior to production.

DISCONTINUED STYLES.

Often a number of styles from previous price lists or catalogs are discontinued or retired from the line and no longer listed in the catalog or price list. This does not always mean that these items are no longer available, but may have been discontinued and replaced with a similar item or may still be available upon request. Please feel free to call our customer service department for information on these particular items.

JURISDICTION

Artista Gallery, Inc. is a Georgia corporation and you agree that this agreement has been entered into in the State of, and its validity, construction, interpretation and legal effect shall be governed by the laws of the State of Georgia applicable to contracts entered into and performed entirely within the State of Georgia. Additionally, you agree that any and all disagreements arising from your use of or orders placed through NewRetroDining.com will be adjudicated in the county of Houston, Georgia by an appropriate federal or state court.

SHIPPING

- All applicable shipping charges are non-refundable.
- The purchaser must make all the necessary arrangements to receive the package from the carrier at the time of delivery. The carrier will contact the buyer by phone at the number provided at the time the order is placed.
- The purchaser is responsible for any additional shipping and/or storage fees which arise in the event the purchaser is not available to receive the shipment at the pre-arranged and designated day and time-range resulting in the carrier needing to re-schedule the delivery appointment.
- The purchaser is responsible for filing any and all claims for wrong, missing, damaged or defective item(s) with Artista Gallery, Inc. within 24 hours of delivery by fax (404) 420-2890, phone (478) 320-2502 or email, RMA@NewRetroDining.com. If not reported within this time acceptance of the item(s) is implied.
- If there is any shipping damage the purchaser is responsible for documenting the damage on the freight bill of lading and sending photographs of the damaged box and damaged items to Artista Gallery, Inc. All items must be thoroughly inspected before the carrier driver leaves your premises. If there is any damage or perceived damage it must be documented on the freight Bill of Lading. If not recorded at the time of delivery then acceptance of the item(s) is implied.
- It is very important to inspect the crate(s) and carton(s) upon arrival. If there is any visual sign of damage to the packaging then you must write "DAMAGED" on the BOL (Bill of Lading) when you sign for the goods, in case there is actual damage to the goods. Please do not refuse the shipment as Artista Gallery, Inc. will file a damage claim with the shipper. We rarely have issues with damage due to shipping. This is just to ensure responsibility for any damages born by the shipper. If there is any damage, please save the cartons. If there is any damage please notify us via email or phone within 24 hours of receiving furniture.
- Buyers should advise preferred shipping and routing with each order. If no carrier is requested by name, or if named carrier does not serve our factory or consignee location, Artista will ship by the method deemed most practical, but will not be responsible for any differences in freight charges.
- All ship dates quoted are approximate. Any orders shipped later than the factory scheduled ship date are free from any penalties imposed by the buyers.

- From the time carrier signs for shipment, Artista no longer has title to the merchandise, and carrier becomes the agent of the consignee. Disposition of shipments refused by consignee is the responsibility of the consignee and or buyer.
- Any additional shipping charges incurred by Artista for matters such as C.O.D. fees, inside delivery, etc., will be billed to the buyer.

SHIPPING SERVICES OFFERED

- Artista Gallery, Inc. offers premium freight shipping services provided by a variety of carriers.
- Actual 70% discounted shipping charges on line-haul shipping will be charged to the purchaser. Curb-side delivery is standard. Additional charges apply for residential inside deliveries.
- An estimated shipping amount will be quoted at the time your order is placed upon request. You

SHORTAGES OR DAMAGE CLAIMS

- Artista is not responsible for loss or damages incurred in transit. Before accepting the merchandise from the carrier, the consignee should inspect and note any loss or damage on the delivery receipt. If there is loss or damage, a claim should be made immediately with the carrier. If damage or loss is discovered after delivery, the carrier should be notified immediately for an inspection of concealed damage as well as for instructions in filing a freight claim. Original packing materials should be saved for inspection if claim is to be filed. Concealed damage claims must be filed with carrier within 10 days of receipt of goods. (Freight company will only cover 1/3 of total cost.).
- Shortages other than loss in transit, or any variance in the specifications of the order must be reported to Artista within 10 days of receipt of goods. Failure to make such claim shall constitute acceptance of the merchandise and a waiver of any defects, errors or shortages.
- Artista's liability shall be limited to the selling price of any defective goods, and shall at no time include profits or loss of profits. All replacement orders for freight - damaged merchandise must be accompanied by a completed and signed copy of the carrier's inspection report.

RETURNS

- No returned merchandise will be accepted by Artista for exchange, credit or repair unless prior written consent is given by the factory. Unauthorized returns will be refused and returned to the consignee freight collect.
- Where returns are authorized, Artista will issue a Return Authorization Form with shipping instructions which must be used with such returns indicating any restocking and/or freight charges that will be billed to the buyer. Restocking charges will range from 25% of the original purchase price.

MISCELLANEOUS

- (a) This agreement constitutes the entire agreement between the parties relative to the subject matter hereof and supersedes all other understandings and agreements between the parties whether oral or written.
- (b) This Agreement may not be modified orally; no waiver, amendment or modification shall be binding or effective unless in writing and signed by the party sought to be bound.
- (c) This Agreement may be executed in one or more counterparts, each of which shall be deemed an original, but all of which together shall constitute one and the same instrument.
- (d) If any part of this Agreement shall be declared invalid or unenforceable by court of competent jurisdiction, it shall not affect the validity of the balance of this Agreement.
- (e) This Agreement shall inure to the benefit of and be binding upon each party and its successors and assigns.
- (f) Nothing contained in this agreement shall constitute a partnership or joint venture between the parties hereto or constitute either party the agent of the other.
- (g) No waiver by either party of any term or provision of this contract or of any default hereunder shall affect your or Artista Gallery, Inc.'s respective rights thereafter to enforce such term or provision or to exercise any right or remedy in the event of any other default, whether or not similar.
- (h) Neither party shall be deemed to be in breach of any of its obligations hereunder unless and until given written notice by certified or registered mail, return receipt requested, of the nature of such breach
-

FLAME RETARDANCY

Municipal requirements regarding flame retardant for use in various types of facilities are constantly changing. As part of our customized service, Artista offers a wide variety of upholstery, foam materials and barrier cloths to meet unique flame retardant specifications.

If buyer must satisfy a particular code, e.g., State of Calif. Technical Bulletin 117 - E, or Boston Fire Dept. Code (BFD 9 - 1), this must be clearly indicated on the purchase order.

Artista will advise buyer of special pricing for this service, but Artista is not liable for noncompliance with local code requirements if the buyer fails to advise Artista of these requirements at the time of purchase.

Note: most flame retardant treatments are salt solutions. Cleaning flame retardant upholstery therefore with water or water - based foams will result in salt ringing. Solvent - based fabric cleaners or dry cleaning are alternate methods of cleaning. However, buyer is cautioned to test proposed cleaning procedures on a small portion of fabric before proceeding with cleaning of the entire installation

LIMITED WARRANTY & LIFETIME WARRANTY

All products manufactured by Artista Seating Products are guaranteed against failure from defective workmanship to the original purchaser, when installed and utilized for their intended purpose. A structural frame warranty applies to weld failures and leg bending. The structural frame warranties are as follows:

Innovations (Lifetime)	Faculty (Lifetime)	265 (2 years)	Wood Chairs (1 year)
Legends (Lifetime)	Parlor (Lifetime)	300 (Lifetime)	Booths (2 years)
Spectrum (Lifetime)	Classic (Lifetime)	400 (Lifetime)	Tables (2 years)
Omni (Lifetime)	215 (2 years)	500 (Lifetime)	Bases (2 years)
Oxford (Lifetime)	250 (Lifetime)	1500/1700/1800 (Lifetime)	Outdoor (1 year)
Stacker (Lifetime)	264 (Lifetime)	Cafe (Varies)	

STRUCTURAL FRAME WARRANTY

Does not apply to any product that has been altered, or subjected to misuse, negligence or accident. Under this warranty, any product proven to be defective shall be repaired or replaced at our option, free of charge, provided it is returned prepaid as directed. In no case shall liability under this warranty exceed the original purchase price of the defective merchandise. We reserve the right to inspect the defective item at our premises, by our factory personnel, to establish the cause of the alleged product failure.

This warranty shall not apply to any product which has been repaired or altered by anyone other than Artista personnel in any way as to affect, in our judgment, its stability and durability, nor which has been subjected to misuse, negligence, abuse or accident.

Artista's product line is for indoor use only (Excluding outdoor furniture), and therefore any damage caused by exposure to the elements, such as salt - air or ultra violet rays, is not covered by this warranty. Even where Artista was apprised of the final destination of an order, it is not liable under this warranty if the merchandise ordered was exposed to the elements. This warranty shall not apply to Artista merchandise which was exposed to harsh or acidic cleaning agents or abrasives.

Artista reserves the right to make changes at any time, without notice, in materials, dimensions, specifications, equipment, colors, design or prices. Artista also reserves the right to make such changes at any time without any obligation to make comparable revisions and/ or modifications on products manufactured at a previous time.

The cost of field repairs performed by non - Artista personnel will not be reimbursed unless expressly authorized in writing by Artista prior to the repair.

Artista does exclude upholstery from this warranty, whether the material is provided by Artista or as COM (Customers Own Material). However, warranties are often provided by the upholstery mill. All upholstery and laminates are subject to warranty offered by the respective manufacturer.

MAINTENANCE

To ensure durability and longevity of Artista's product line and customer satisfaction, periodic inspection and maintenance is necessary. Buyers should therefore advise their clients to inspect merchandise at regular intervals — particularly the joints, welds, swivels and other points of stress as well as missing glides, screws or bolts, and to clean and tighten screws and bolts, and grease parts where necessary. If repair parts are needed, use only Artista replacement parts and attachment methods.

If an item shows any sign of structural fatigue, it should be taken out of service immediately. If covered by warranty, Artista should be notified immediately. Any continued use of the product is at buyer's risk and Artista's warranty will no longer be valid.

Freight quotes are valid for 30 days.

Freight Classes (LTL)

Barstools (<i>Bases & heads packed separately</i>)	Bases 70 / Heads 85 Barstools (<i>KD</i>)
100	
Barstools (<i>Set-up, except Omni, Spectrum</i>)	125
Barstools (<i>Omni & Spectrum</i>)	(See chairs)
Bases (<i>KD</i>)	70
Booths (<i>KD</i>)	85
Booths (<i>Set-up</i>)	150
Chairs (<i>4 or more per carton</i>)	125
Chairs (<i>Less than 4 per carton</i>)	150
Chair Caddy	70
Chair Dolly	70
Chair Frames (<i>Nested</i>)	100
Costumers	85
Fountain Stools	(See barstools)
Seats & Backs (<i>Parts</i>)	85 Table Tops
Table Bases	(See bases)

Upholstery Grades

Naugahyde Stratford	Grade 1
Naugahyde Rogue II	Grade 2
Morbern Seabrook	Grade 2
Spradling Patriot Plus	Grade 3
Cracked Ice	Grade 3
Nassimi Seaquest	Grade 4
Culp Tea Time	Grade 4
Culp Fandango	Grade 4
Culp Dillon	Grade 4
Culp Gavotte	Grade 4
Culp Critic's Choice	Grade 4
Culp Winslow	Grade 4
Naugahyde Zodiac	Grade 5
Naugahyde English Pub	Grade 5
Piano	Grade 10



CHAIRS & STOOLS

NewRetroDining.com

Made in USA - Retro 50's Furniture

Innovations

*All Innovation Frames Are Painted Only



INN - 2100

Features

31" H x 18" W x 18" D
18" Seat Height
1 1/4" Pulled Seat
1 1/4" Sq. Steel Tubing (16 Gauge)
#18 Butyrate Heavy Duty Glide

Optional:

3/4" Wood Seat (Add \$61.88 Grade 1)

Quantity	Grade 1	Grade 2	Grade 3	Grade 4	Grade 5
100+	231.88	235.38	238.88	242.37	245.87
50 - 99	235.38	238.88	242.37	245.87	249.37
11 - 49	238.88	242.37	245.87	249.37	252.88
1 - 10	262.21	265.70	269.20	272.70	276.19

COM Yardage: 1/2 yd. - price @ GR 1
Items Per Carton: 2

Weight: 18 lbs, Wood 21 lbs
Shipping Class: 150



INN - 2110 BS

Features

41" H x 18" W x 18" D
30" Seat Height
1 1/4" Pulled Seat
1 1/4" Sq. Steel Tubing (16 Gauge)
#18 Butyrate Heavy Duty Glide

Optional:

3/4" Wood Seat (Add \$61.88 Grade 1)
24" Seat Height (Add \$20.76)

Quantity	Grade 1	Grade 2	Grade 3	Grade 4	Grade 5
7+	278.56	282.05	285.55	289.04	292.54
1 - 6	301.89	305.38	308.88	312.38	315.87

COM Yardage: 1/2 yd. - price @ GR 1
Items Per Carton: 1

Weight: 25 lbs, Wood 27 lbs
Shipping Class: 150



600 - INN - 2120 BS

Features

41" H x 17" W x 18" D
1 1/4" Pulled Seat
1 1/4" Sq. Steel Tubing (16 Gauge)
#18 Butyrate Heavy Duty Glide
#20 DBL Plate Swivel

Optional:

3/4" Wood Seat (Add \$61.88 Grade 1)
24" or 30" Seat Height

Quantity	Grade 1	Grade 2	Grade 3	Grade 4	Grade 5
7+	343.89	347.38	350.88	354.38	357.87
1 - 6	367.22	370.71	374.21	377.71	381.20

COM Yardage: 1/2 yd. - price @ GR 1
Items Per Carton: 1

Weight: 30 lbs, Wood 32 lbs
Shipping Class: 150



1800 - INN - 2120 BS

Features

41" H x 17" W x 18" D
1 1/4" Pulled Seat
3" Sq. Column w/ Cast Iron Bottom
#22 DBL Plate Seat Return Swivel

Optional:

3/4" Wood Seat (Add \$61.88 Grade 1)
18", 24", or 30" Seat Height
Footrest (Shown is 606: Add \$89.91)

Quantity	Grade 1	Grade 2	Grade 3	Grade 4	Grade 5
7+	367.22	370.71	374.21	377.71	381.20
1 - 6	390.55	394.04	397.54	401.04	404.53

COM Yardage: 1/2 yd. - price @ GR 1
Items Per Carton: Varies

Weight: 36 lbs, Wood 38 lbs
Shipping Class: Head - 85, Base - 70

Specify Floor Attachment:
Type B (Wood)
Type C (Concrete)

*Footrest not available on 18"

Curved Wood Back

*All Innovation Frames Are Painted Only



INN - 2200

Features

31" H x 18" W x 18" D
18" Seat Height
1 1/4" Pulled Seat
1 1/4" Sq. Steel Tubing (16 Gauge)
#18 Butyrate Heavy Duty Glide

Optional:

3/4" Wood Seat (Add \$61.88 Grade 1)

Quantity	Grade 1	Grade 2	Grade 3	Grade 4	Grade 5
100+	200.09	203.58	207.08	210.58	214.07
50 - 99	203.58	207.08	210.58	214.07	217.57
11 - 49	207.08	210.58	214.07	217.57	221.07
1 - 10	230.41	233.91	237.41	240.90	244.40

COM Yardage: 1/2 yd. - price @ GR 1
Items Per Carton: 2

Weight: 18 lbs, Wood 21 lbs
Shipping Class: 150



INN - 2210 BS

Features

41" H x 18" W x 18" D
30" Seat Height
1 1/4" Pulled Seat
1 1/4" Sq. Steel Tubing (16 Gauge)
#18 Butyrate Heavy Duty Glide

Optional:

3/4" Wood Seat (Add \$61.88 Grade 1)
24" Seat Height (Add \$20.76)

Quantity	Grade 1	Grade 2	Grade 3	Grade 4	Grade 5
7+	246.75	250.25	253.74	257.24	260.74
1 - 6	270.08	273.58	277.07	280.57	284.07

COM Yardage: 1/2 yd. - price @ GR 1
Items Per Carton: 1

Weight: 25 lbs, Wood 27 lbs
Shipping Class: 150



600 - INN - 2220 BS

Features

41" H x 17" W x 18" D
1 1/4" Pulled Seat
1 1/4" Sq. Steel Tubing (16 Gauge)
#18 Butyrate Heavy Duty Glide
#20 DBL Plate Swivel

Optional:

3/4" Wood Seat (Add \$61.88 Grade 1)
24" or 30" Seat Height

Quantity	Grade 1	Grade 2	Grade 3	Grade 4	Grade 5
7+	308.93	312.43	315.93	319.43	322.93
1 - 6	335.41	338.91	342.41	345.90	349.40

COM Yardage: 1/2 yd. - price @ GR 1
Items Per Carton: 1

Weight: 30 lbs, Wood 32 lbs
Shipping Class: 150



1800 - INN - 2220 BS

Features

41" H x 17" W x 18" D
1 1/4" Pulled Seat
3" Sq. Column w/ Cast Iron Bottom
#22 DBL Plate Seat Return Swivel

Optional:

3/4" Wood Seat (Add \$61.88 Grade 1)
18", 24", or 30" Seat Height
Footrest (Shown is 606: Add \$89.91)

Quantity	Grade 1	Grade 2	Grade 3	Grade 4	Grade 5
7+	335.41	338.91	342.41	345.90	349.40
1 - 6	358.74	362.24	365.74	369.23	372.73

COM Yardage: 1/2 yd. - price @ GR 1
Items Per Carton: Varies

Weight: 36 lbs, Wood 38 lbs
Shipping Class: Head - 85, Base - 70

Specify Floor Attachment:

Type B (Wood)
Type C (Concrete)

*Footrest not available on 18"

Round Wood Back

**All Innovation Frames Are Painted Only*



INN - 2300

Features

31" H x 18" W x 18" D
18" Seat Height
1 1/4" Pulled Seat
1 1/4" Sq. Steel Tubing (16 Gauge)
#18 Butyrate Heavy Duty Glide

Optional:

3/4" Wood Seat (Add \$61.88 Grade 1)

Quantity	Grade 1	Grade 2	Grade 3	Grade 4	Grade 5
100+	221.13	224.63	228.12	231.62	235.12
50 - 99	224.63	228.12	231.62	235.12	238.61
11 - 49	228.12	231.62	235.12	238.61	242.11
1 - 10	251.45	254.95	258.45	261.94	265.44

COM Yardage: 1/2 yd. - price @ GR 1
Items Per Carton: 2

Weight: 18 lbs, Wood 21 lbs
Shipping Class: 150



INN - 2310 BS

Features

41" H x 18" W x 18" D
30" Seat Height
1 1/4" Pulled Seat
1 1/4" Sq. Steel Tubing (16 Gauge)
#18 Butyrate Heavy Duty Glide

Optional:

3/4" Wood Seat (Add \$61.88 Grade 1)
24" Seat Height (Add \$20.76)

Quantity	Grade 1	Grade 2	Grade 3	Grade 4	Grade 5
7+	267.79	271.29	274.79	278.28	281.78
1 - 6	291.12	294.62	298.12	301.61	305.11

COM Yardage: 1/2 yd. - price @ GR 1
Items Per Carton: 1

Weight: 25 lbs, Wood 27 lbs
Shipping Class: 150



600 - INN - 2320 BS

Features

41" H x 17" W x 18" D
1 1/4" Pulled Seat
1 1/4" Sq. Steel Tubing (16 Gauge)
#18 Butyrate Heavy Duty Glide
#20 DBL Plate Swivel

Optional:

3/4" Wood Seat (Add \$61.88 Grade 1)
24" or 30" Seat Height

Quantity	Grade 1	Grade 2	Grade 3	Grade 4	Grade 5
7+	333.13	336.63	340.13	343.62	347.12
1 - 6	356.46	359.96	363.46	366.95	370.45

COM Yardage: 1/2 yd. - price @ GR 1
Items Per Carton: 1

Weight: 30 lbs, Wood 32 lbs
Shipping Class: 150



1800 - INN - 2320 BS

Features

41" H x 17" W x 18" D
1 1/4" Pulled Seat
3" Sq. Column w/ Cast Iron Bottom
#22 DBL Plate Seat Return Swivel

Optional:

3/4" Wood Seat (Add \$61.88 Grade 1)
18", 24", or 30" Seat Height
Footrest (Shown is 606: Add \$89.91)

Quantity	Grade 1	Grade 2	Grade 3	Grade 4	Grade 5
7+	356.46	359.96	363.46	366.95	370.45
1 - 6	379.80	383.29	386.79	390.29	393.78

COM Yardage: 1/2 yd. - price @ GR 1
Items Per Carton: Varies

Weight: 36 lbs, Wood 38 lbs
Shipping Class: Head - 85, Base - 70

Specify Floor Attachment:
Type B (Wood)
Type C (Concrete)

**Footrest not available on 18"*

Wood & Metal Lattice Back

*All Innovation Frames Are Painted Only



INN - 2400

Features

31" H x 18" W x 18" D
18" Seat Height
1 1/4" Pulled Seat
1 1/4" Sq. Steel Tubing (16 Gauge)
#18 Butyrate Heavy Duty Glide

Optional:

3/4" Wood Seat (Add \$61.88 Grade 1)

Quantity	Grade 1	Grade 2	Grade 3	Grade 4	Grade 5
100+	200.09	203.58	207.08	210.58	214.07
50 - 99	203.58	207.08	210.58	214.07	217.57
11 - 49	207.08	210.58	214.07	217.57	221.07
1 - 10	230.41	233.91	237.41	240.90	244.40

COM Yardage: 1/2 yd. - price @ GR 1
Items Per Carton: 2

Weight: 18 lbs, Wood 21 lbs
Shipping Class: 150



INN - 2410 BS

Features

41" H x 18" W x 18" D
30" Seat Height
1 1/4" Pulled Seat
1 1/4" Sq. Steel Tubing (16 Gauge)
#18 Butyrate Heavy Duty Glide

Optional:

3/4" Wood Seat (Add \$61.88 Grade 1)
24" Seat Height (Add \$20.76)

Quantity	Grade 1	Grade 2	Grade 3	Grade 4	Grade 5
7+	246.75	250.25	253.74	257.24	260.74
1 - 6	270.08	273.58	277.07	280.57	284.07

COM Yardage: 1/2 yd. - price @ GR 1
Items Per Carton: 1

Weight: 25 lbs, Wood 27 lbs
Shipping Class: 150



600 - INN - 2420 BS

Features

41" H x 17" W x 18" D
1 1/4" Pulled Seat
1 1/4" Sq. Steel Tubing (16 Gauge)
#18 Butyrate Heavy Duty Glide
#20 DBL Plate Swivel

Optional:

3/4" Wood Seat (Add \$61.88 Grade 1)
24" or 30" Seat Height

Quantity	Grade 1	Grade 2	Grade 3	Grade 4	Grade 5
7+	312.08	315.58	319.07	322.57	326.07
1 - 6	335.41	338.91	342.41	345.90	349.40

COM Yardage: 1/2 yd. - price @ GR 1
Items Per Carton: 1

Weight: 30 lbs, Wood 32 lbs
Shipping Class: 150



1800 - INN - 2420 BS

Features

41" H x 17" W x 18" D
1 1/4" Pulled Seat
3" Sq. Column w/ Cast Iron Bottom
#22 DBL Plate Seat Return Swivel

Optional:

3/4" Wood Seat (Add \$61.88 Grade 1)
18", 24", or 30" Seat Height
Footrest (Shown is 606: Add \$89.91)

Quantity	Grade 1	Grade 2	Grade 3	Grade 4	Grade 5
7+	335.41	338.91	342.41	345.90	349.40
1 - 6	358.74	362.24	365.74	369.23	372.73

COM Yardage: 1/2 yd. - price @ GR 1
Items Per Carton: Varies

Weight: 36 lbs, Wood 38 lbs
Shipping Class: Head - 85, Base - 70

Specify Floor Attachment:

Type B (Wood)
Type C (Concrete)

*Footrest not available on 18"

Wood & Metal Criss Cross Back

*All Innovation Frames Are Painted Only



INN - 2500

Features

31" H x 18" W x 18" D
18" Seat Height
1 1/4" Pulled Seat
1 1/4" Sq. Steel Tubing (16 Gauge)
#18 Butyrate Heavy Duty Glide

Optional:

3/4" Wood Seat (Add \$61.88 Grade 1)

Quantity	Grade 1	Grade 2	Grade 3	Grade 4	Grade 5
100+	200.09	203.58	207.08	210.58	214.07
50 - 99	203.58	207.08	210.58	214.07	217.57
11 - 49	207.08	210.58	214.07	217.57	221.07
1 - 10	230.41	233.91	237.41	240.90	244.40

COM Yardage: 1/2 yd. - price @ GR 1
Items Per Carton: 2

Weight: 18 lbs, Wood 21 lbs
Shipping Class: 150



INN - 2510 BS

Features

41" H x 18" W x 18" D
30" Seat Height
1 1/4" Pulled Seat
1 1/4" Sq. Steel Tubing (16 Gauge)
#18 Butyrate Heavy Duty Glide

Optional:

3/4" Wood Seat (Add \$61.88 Grade 1)
24" Seat Height (Add \$20.76)

Quantity	Grade 1	Grade 2	Grade 3	Grade 4	Grade 5
7+	246.75	250.25	253.74	257.24	260.74
1 - 6	270.08	273.58	277.07	280.57	284.07

COM Yardage: 1/2 yd. - price @ GR 1
Items Per Carton: 1

Weight: 25 lbs, Wood 27 lbs
Shipping Class: 150



600 - INN - 2520 BS

Features

41" H x 17" W x 18" D
1 1/4" Pulled Seat
1 1/4" Sq. Steel Tubing (16 Gauge)
#18 Butyrate Heavy Duty Glide
#20 DBL Plate Swivel

Optional:

3/4" Wood Seat (Add \$61.88 Grade 1)
24" or 30" Seat Height

Quantity	Grade 1	Grade 2	Grade 3	Grade 4	Grade 5
7+	335.41	338.91	342.41	345.90	349.40
1 - 6	358.74	362.25	365.75	369.24	372.74

COM Yardage: 1/2 yd. - price @ GR 1
Items Per Carton: 1

Weight: 30 lbs, Wood 32 lbs
Shipping Class: 150



1800 - INN - 2520 BS

Features

41" H x 17" W x 18" D
1 1/4" Pulled Seat
3" Sq. Column w/ Cast Iron Bottom
#22 DBL Plate Seat Return Swivel

Optional:

3/4" Wood Seat (Add \$61.88 Grade 1)
18", 24", or 30" Seat Height
Footrest (Shown is 606: Add \$89.91)

Quantity	Grade 1	Grade 2	Grade 3	Grade 4	Grade 5
7+	358.74	362.25	365.75	369.24	372.74
1 - 6	382.08	385.58	389.08	392.57	396.07

COM Yardage: 1/2 yd. - price @ GR 1
Items Per Carton: Varies

Weight: 36 lbs, Wood 38 lbs
Shipping Class: Head - 85, Base - 70

Specify Floor Attachment:

Type B (Wood)
Type C (Concrete)

*Footrest not available on 18"

Curved Wood Back & Metal Slats

*All Shown With Optional Wood Seat *All Innovation Frames Are Painted Only



INN - 2600

Features

31" H x 18" W x 18" D
18" Seat Height
1 1/4" Pulled Seat
1 1/4" Sq. Steel Tubing (16 Gauge)
#18 Butyrate Heavy Duty Glide

Optional:

3/4" Wood Seat (Add \$61.88 Grade 1)

Quantity	Grade 1	Grade 2	Grade 3	Grade 4	Grade 5
100+	207.44	210.93	214.43	217.93	221.42
50 - 99	210.93	214.43	217.93	221.42	224.92
11 - 49	214.43	217.93	221.42	224.92	228.42
1 - 10	237.76	241.26	244.76	248.25	251.75

COM Yardage: 1/2 yd. - price @ GR 1
Items Per Carton: 2

Weight: 18 lbs, Wood 21 lbs
Shipping Class: 150



INN - 2610 BS

Features

41" H x 18" W x 18" D
30" Seat Height
1 1/4" Pulled Seat
1 1/4" Sq. Steel Tubing (16 Gauge)
#18 Butyrate Heavy Duty Glide

Optional:

3/4" Wood Seat (Add \$61.88 Grade 1)
24" Seat Height (Add \$20.76)

Quantity	Grade 1	Grade 2	Grade 3	Grade 4	Grade 5
7+	254.10	257.60	261.09	264.59	268.09
1 - 6	277.43	280.93	284.42	287.92	291.42

COM Yardage: 1/2 yd. - price @ GR 1
Items Per Carton: 1

Weight: 25 lbs, Wood 27 lbs
Shipping Class: 150



600 - INN - 2620 BS

Features

41" H x 17" W x 18" D
1 1/4" Pulled Seat
1 1/4" Sq. Steel Tubing (16 Gauge)
#18 Butyrate Heavy Duty Glide
#20 DBL Plate Swivel

Optional:

3/4" Wood Seat (Add \$61.88 Grade 1)
24" or 30" Seat Height

Quantity	Grade 1	Grade 2	Grade 3	Grade 4	Grade 5
7+	319.43	322.93	326.42	329.92	333.42
1 - 6	342.76	346.26	349.76	353.25	356.75

COM Yardage: 1/2 yd. - price @ GR 1
Items Per Carton: 1

Weight: 30 lbs, Wood 32 lbs
Shipping Class: 150



1800 - INN - 2620 BS

Features

41" H x 17" W x 18" D
1 1/4" Pulled Seat
3" Sq. Column w/ Cast Iron Bottom
#22 DBL Plate Seat Return Swivel

Optional:

3/4" Wood Seat (Add \$61.88 Grade 1)
18", 24", or 30" Seat Height
Footrest (Shown is 606: Add \$89.91)

*Footrest not available on 18"

Quantity	Grade 1	Grade 2	Grade 3	Grade 4	Grade 5
7+	342.76	346.26	349.76	353.25	356.75
1 - 6	366.09	369.59	373.09	376.58	380.08

COM Yardage: 1/2 yd. - price @ GR 1
Items Per Carton: Varies

Weight: 36 lbs, Wood 38 lbs
Shipping Class: Head - 85, Base - 70

Specify Floor Attachment:

Type B (Wood)
Type C (Concrete)

Cafe Collection



ADR - 200

Features

34" H x 17" W x 17" D
 18" Seat Height
 1" Sq. Steel Tubing (16 Gauge)
 Laminated Plywood Seat & Back
 #1 Heavy Duty Platform Glide
 Powder Coated Frame
 Walnut & Natural Laminates
 Lifetime Structural Frame Warranty

Quantity

100+	212.06
50 - 99	215.56
11 - 49	219.05
1 - 10	242.38

COM Yardage: N/A

Weight: 18 lbs

Items Per Carton: 2

Shipping Class: 150



ADR - 1200 BS

Features

43" H x 17" W x 17" D
 30" Seat Height
 1" Sq. Steel Tubing (16 Gauge)
 Laminated Plywood Seat & Back
 #1 Heavy Duty Platform Glide
 Powder Coated Frame
 Walnut & Natural Laminates
 Lifetime Structural Frame Warranty

Quantity

7+	256.66
1 - 6	279.99

COM Yardage: N/A

Weight: 27 lbs

Items Per Carton: 1

Shipping Class: 150



BRD - 1000 BS

Features

30" H x 15½" W x 15½" D
 30" Seat Height Only
 1¼" Sq. Steel Tubing (16 Gauge)
 1¼" Pulled Seat
 Powder Coated Frame
 #18 Butyrate Glides
 Non - Swivel
 Lifetime Structural Frame Warranty

Quantity

Quantity	Grade 1	Grade 2	Grade 3	Grade 4	Grade 5
7+	163.31	166.80	170.30	173.80	177.29
1 - 6	186.64	190.13	193.63	197.13	200.62

COM Yardage: ½ yd. - price @ GR 1

Weight: 18 lbs

Items Per Carton: 1

Shipping Class: 150



BRD - 1100 BS

Features

42" H x 15½" W x 15½" D
 30" Seat Height Only
 1¼" Sq. Steel Tubing (16 Gauge)
 1¼" Pulled Seat
 Powder Coated Frame
 #18 Butyrate Glides
 Non - Swivel
 Lifetime Structural Frame Warranty

Quantity

Quantity	Grade 1	Grade 2	Grade 3	Grade 4	Grade 5
7+	244.75	248.25	251.74	255.23	258.73
1 - 6	268.08	271.57	275.07	278.57	282.06

COM Yardage: ½ yd. - price @ GR 1

Weight: 27 lbs

Items Per Carton: 1

Shipping Class: 150

Minimum Quantity Shown For Each Item



HPN - 100

Features

33" H x 20" D x 18½" W
18" Seat Height
Aluminum Chair
1 Year Warranty

Optional:

Powder Coat Paint (Add \$21.11)
(Shown with Cardinal Paint)

Available in all paint colors

Quantity

50+	199.31
10 - 49	205.47

COM Yardage: N/A

Weight: 9 lbs

Items Per Carton: 2

Shipping Class: 150



HPN - 1100 BS

Features

42" H x 19" D x 16" W
30" Seat Height
Aluminum Stool
1 Year Warranty

Optional:

Powder Coat Paint (Add \$21.11)

Available in all paint colors

Quantity

7+	290.25
----	--------

COM Yardage: N/A

Weight: 15 lbs

Items Per Carton: 1

Shipping Class: 100



HPN - 1150 BS

Features

30" H x 14½" D x 14½" W
30" Seat Height
Aluminum Stool
Swivels 360°
1 Year Warranty
Paint Not Available

Optional:

24" Seat Height Available

Quantity

7+	208.82
----	--------

COM Yardage: N/A

Weight: 15 lbs

Items Per Carton: 1

Shipping Class: 150



LKE - 100

Features

33½" H x 20" D x 17½" W
18" Seat Height
Resin Reinforced w/ Steel Frame
Stacks 5 High
1 Year Warranty
3 Colors Available:



Red Pesca Light gray

Quantity

50+	122.32
10 - 49	126.40

COM Yardage: N/A

Weight: 10 lbs

Items Per Carton: 4

Shipping Class: 150

Minimum Quantity Shown For Each Item



MAD - 100

Features

35½" H x 17½" W x 17" D
 18" Seat Height
 1¼" Pulled Seat
 1" Rd. Steel Tubing (14 Gauge)
 Beechwood Back Panel
 J.I.B Glides
 Lifetime Warranty

Quantity	Grade 1	Grade 2	Grade 3	Grade 4	Grade 5
100+	208.84	212.33	215.83	219.32	222.82
50 – 99	212.33	215.83	219.32	222.82	226.32
11 – 49	215.83	219.32	222.82	226.32	229.81
1 – 10	239.16	242.66	246.15	249.65	253.15

COM Yardage: ½ yd. - price @ GR 1
 Items Per Carton: 2

Weight: 18 lbs
 Shipping Class: 150



MAD - 1100 BS

Features

43" H x 17 ½" W x 17" D
 30" Seat Height
 1¼" Pulled Seat
 1" Rd. Steel Tubing (14 Gauge)
 Beechwood Back Panel
 J.I.B Glides
 Lifetime Warranty

Quantity	Grade 1	Grade 2	Grade 3	Grade 4	Grade 5
7+	257.84	261.34	264.83	268.33	271.82
1 – 6	281.17	284.67	288.16	291.66	295.16

COM Yardage: ½ yd. - price @ GR 1
 Items Per Carton: 1

Weight: 30 lbs
 Shipping Class: 150



MKT - 100

Features

31" H x 16½" W x 17" D
 18" Seat Height
 Curved Plywood Seat & Back
 Tapered Metal Legs
 Powder Coated Gloss Black Frame
 Platform Glides
 Natural Wood Stain Only
 1 Year Warranty

Quantity	
50+	232.68
10 – 49	239.88

COM Yardage: N/A
 Items Per Carton: 2

Weight: 12 lbs
 Shipping Class: 150



MKT - 1100 BS

Features

43" H x 16½" W x 17" D
 30" Seat Height
 Curved Plywood Seat & Back
 Tapered Metal Legs
 Powder Coated Gloss Black Frame
 Platform Glides
 Natural Wood Stain Only
 1 Year Warranty

Quantity	
7+	284.59

COM Yardage: N/A
 Items Per Carton: 1

Weight: 15 lbs
 Shipping Class: 150

Minimum Quantity Shown For Each Item



OSG - 100

Features

33" H x 18" W x 21" D
18" Seat Height
1 Year Warranty

Optional:

Walnut, Dark Mahogany,
and Zebra

Quantity

50+	262.12
10 - 49	270.23

COM Yardage: N/A

Weight: 12 lbs

Items Per Carton: 2

Shipping Class: 150



OSG - 1100 BS

Features

42" H x 17" W x 21" D
30" Seat Height
1 Year Warranty

Optional:

Walnut, Dark Mahogany,
and Zebra

Quantity

7+	329.41
----	--------

COM Yardage: N/A

Weight: 14 lbs

Items Per Carton: 1

Shipping Class: 150



OSW - 100

Features

32" H x 18½" W x 19" D
18" Seat Height
Stacks 6 High
Chrome Frame
1 Year Warranty

Optional:

Cherry, Dark Mahogany, Natural,
and Zebra

Quantity

50+	139.60
10 - 49	143.92

COM Yardage: N/A

Weight: 11 lbs

Items Per Carton: 2

Shipping Class: 150



PRK - 100

Features

33" H x 20" W x 20½" D
18" Seat Height
Stacks 3 - 5
Chrome Frame
1 Year Warranty

Optional:

Black Onyx, Sandlewood,
and Mocha.

Quantity

50+	174.35
10 - 49	179.75

COM Yardage: N/A

Weight: 12 lbs

Items Per Carton: 2

Shipping Class: 150

Available Shell Colors Shown Below

**1155****Features**

29 ½" H x 20" W x 23 ½" D
 18" Seat Height
 1" Sq. Steel Tubing (16 Gauge)
 #1 Heavy Duty Platform Glides
 Heavy Duty Fiberglass Shell
 Powder Coated Frame

Optional:

\$35.00 for Chrome Legs

Stacks 15 High**Quantity**

250+	137.97
50 – 249	141.46
11 – 49	144.96
1 – 10	168.29

COM Yardage: N/A

Weight: 20 lbs

Items Per Carton: 4

Shipping Class: 150

**1155 BS****Features**

43" H x 20" W x 23 ½" D
 30" Seat Height
 1" Sq. Steel Tubing (16 Gauge)
 #1 Heavy Duty Platform Glides
 Heavy Duty Fiberglass Shell
 Powder Paint Coated Frame Only

Quantity

11+	180.55
1 – 10	203.89

COM Yardage: N/A

Weight: 30 lbs

Items Per Carton: 1

Shipping Class: 150

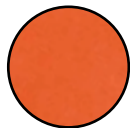
Shell Colors Available

Burnt Orange

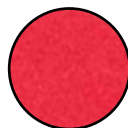

Crimson



Fog Gray



Jet Black

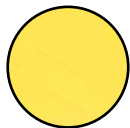

Prairie
Yellow



Navy Blue

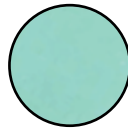

Turquoise

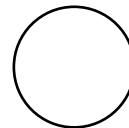

White

Manhattan



Rustic Walnut Frame

MAN - 100

Features

34 1/2" H x 17 1/2" W x 16" D
 18" Seat Height
 Solid European Beechwood
 Rustic Walnut & Natural Frame

Optional:

Upholstered Seat Pad (*Add \$66.93 Up To Grade 5*)
 Veneer Seat

* Minimum Quantity Shown

Quantity	Veneer
50+	232.68
10 - 49	239.88

COM Yardage: N/A

Weight: 18 lbs

Items Per Carton: 2

Shipping Class: 150



MAN - 1100 BS

Features

30" H x 19" W x 19" D
 30" Seat Height
 Non - Swivel
 Solid European Beechwood
 Upholstered w/ Chrome Nailheads

Optional:

Cherry, Mahogany, Walnut,
 and Dark Mahogany Frame

* Minimum Quantity Shown

Quantity	Grades 1 - 5
7+	284.60

COM Yardage: 1/2 yd. - price @ GR 1

Weight: 18 lbs

Items Per Carton: 1

Shipping Class: 150

To place your order

Ph: (478) 320-2502

Email: Jack@NewRetroDining.com



Add \$88.32)

Optional:

Please Note:

If the back is vinyl nailheads must be used, if fabric it is optional. The Brass Finish (aluminum) footrest are no-charge but must be specified.



MAN - 220

Features

34" H x 19" W x 22" D

18" Seat Height

Solid Beech Hardwood

Gunstock Walnut Frame Only

- 5



- price @ GR 1

Minimum Quantity Shown For Each Item



MAN - 1220 BS

Features

44½" H x 18" W x 20" D
30" Seat Height
Solid Beech Hardwood
Gunstock Walnut Frame Only

Optional:

Brass Footrest (*Add \$11.83*)

Quantity Grades 1 - 5

7+ 492.54

COM Yardage: 1 yd. - price @ GR 1

Weight: 25 lbs

Items Per Carton: 1

Shipping Class: 150



MAN - 250 PS4

Features

33½" H x 18" W x 19" D
18" Seat Height
Upholstered Seat & Back
Nail Head Trim

Optional:

Dark Mahogany, Mahogany,
Natural, Walnut, Cherry,
and Black Frame

Quantity Grades 1 - 5

50+ 499.57

10 - 49 515.03

COM Yardage: 1¼ yds. - price @ GR 1

Weight: 18 lbs

Items Per Carton: 2

Shipping Class: 150



MAN - 250 PS3

Features

33½" H x 18" W x 19" D
18" Seat Height
Nail Head Trim

Optional:

Dark Mahogany, Mahogany,
Natural, Walnut, Cherry,
and Black Frame

Quantity Grades 1 - 5

50+ 510.42

10 - 49 526.21

COM Yardage: 1¼ yds. - price @ GR 1

Weight: 18 lbs

Items Per Carton: 2

Shipping Class: 150



MAN - 1250 BS

Features

44½" H x 18½" W x 19" D
30" Seat Height
Nail Head Trim
Solid European Beechwood
Reinforced w/ Metal Brackets

Optional:

Brass Footrest (*Add \$11.83*)
Dark Mahogany, Mahogany,
Natural, Walnut, Cherry,
and Black Frame

Quantity Grades 1 - 5

7+ 593.14

COM Yardage: 1¼ yds. - price @ GR 1

Weight: 25 lbs

Items Per Carton: 1

Shipping Class: 150

Minimum Quantity Shown For Each Item



MAN - 300 FP

Features

36" H x 17" W x 21" D
 18" Seat Height
 Upholstered Seat & Back

Optional:

Cherry, Mahogany,
 and Walnut Frame

Quantity Grades 1 - 5

50+	312.00
10 - 49	321.65

COM Yardage: 1¼ yds. - price @ GR 1

Weight: 18 lbs

Items Per Carton: 2

Shipping Class: 150



MAN - 400 PS4

Features

37" H x 18" W x 22" D
 18" Seat Height
 Upholstered Seat & Back

Optional:

Dark Mahogany, Mahogany,
 Natural, Walnut, Cherry,
 and Black Frame

Quantity Grades 1 - 5

50+	477.89
10 - 49	515.03

COM Yardage: 1¼ yds. - price @ GR 1

Weight: 18 lbs

Items Per Carton: 2

Shipping Class: 150



Woodland



Slatback Chair

* Shown with optional wood seat

WLS - 100

Features

32½" H x 16½" W x 20" D
18" Seat Height
Solid Beech Hardwood
Nylon Glide
6 Standard Stains

Optional:

¾" Wood Seat (Add \$61.88 Grade 1)

Quantity	Grade 1	Grade 2	Grade 3	Grade 4	Grade 5
150+	184.18	187.85	191.51	195.17	198.84
51 - 149	187.85	191.51	195.17	198.84	202.50
1 - 50	212.29	215.95	219.62	223.28	226.94

COM Yardage: ½ yd. - price @ GR 1

Weight: 16 lbs, Wood 18 lbs

Items Per Carton: 2

Shipping Class: 150



Slatback Stool

WLS - 1000 BS

Features

43½" H x 16½" W x 20" D
30" Seat Height
Solid Beech Hardwood
Nylon Glide
6 Standard Stains

Optional:

¾" Wood Seat (Add \$61.88 Grade 1)

Brass Footrest (Add \$11.83)

Quantity	Grade 1	Grade 2	Grade 3	Grade 4	Grade 5
150+	222.68	226.35	230.01	233.67	237.34
51 - 149	226.35	230.01	233.67	237.34	241.00
1 - 50	250.79	254.45	258.12	261.78	265.44

COM Yardage: ½ yd. - price @ GR 1

Weight: 21 lbs, Wood 23 lbs

Items Per Carton: 1

Shipping Class: 150



Diamondback Chair

WLS - 130

Features

33½" H x 16" W x 19" D
18" Seat Height
Solid Beech Hardwood
Nylon Glide
6 Standard Stains

Optional:

¾" Wood Seat (Add \$61.88 Grade 1)

Quantity	Grade 1	Grade 2	Grade 3	Grade 4	Grade 5
150+	187.86	191.52	195.18	198.85	202.51
51 - 149	191.52	195.18	198.85	202.51	206.17
1 - 50	215.96	219.63	223.29	226.95	230.62

COM Yardage: ½ yd. - price @ GR 1

Weight: 16 lbs, Wood 18 lbs

Items Per Carton: 2

Shipping Class: 150



Diamondback Stool

WLS - 1130 BS

Features

43½" H x 16" W x 19" D
30" Seat Height
Solid Beech Hardwood
Nylon Glide
6 Standard Stains

Optional:

¾" Wood Seat (Add \$61.88 Grade 1)

Brass Footrest (Add \$11.83)

Quantity	Grade 1	Grade 2	Grade 3	Grade 4	Grade 5
150+	226.58	230.24	233.90	237.57	241.23
51 - 149	230.24	233.90	237.57	241.23	244.89
1 - 50	254.68	258.35	262.01	265.67	269.34

COM Yardage: ½ yd. - price @ GR 1

Weight: 21 lbs, Wood 23 lbs

Items Per Carton: 1

Shipping Class: 150



Flatback Chair

WLS - 135**Features**

36" H x 18" W x 17" D
 18" Seat Height
 Solid Beech Hardwood
 Nylon Glide
 6 Standard Stains

Optional:

¾" Wood Seat (Add \$61.88 Grade 1)

Quantity	Grade 1	Grade 2	Grade 3	Grade 4	Grade 5
150+	300.35	303.68	307.01	310.34	313.67
51 - 149	303.68	307.01	310.34	313.67	317.00
1 - 50	325.90	329.23	332.56	335.89	339.22

COM Yardage: ½ yd. - price @ GR 1

Weight: 20 lbs, Wood 22 lbs

Items Per Carton: 2

Shipping Class: 150



Flatback Stool

WLS - 1135 BS**Features**

44" H x 18" W x 17" D
 30" Seat Height
 Solid Beech Hardwood
 Nylon Glide
 6 Standard Stains

Optional:

¾" Wood Seat (Add \$61.88 Grade 1)
 Brass Footrest (Add \$11.83)

Quantity	Grade 1	Grade 2	Grade 3	Grade 4	Grade 5
150+	336.35	339.68	343.01	346.34	349.67
51 - 149	339.68	343.01	346.34	349.67	353.00
1 - 50	361.90	365.23	368.56	371.89	375.22

COM Yardage: ½ yd. - price @ GR 1

Weight: 23 lbs, Wood 25 lbs

Items Per Carton: 1

Shipping Class: 150



Horizontal 6 Chair

WLS - 145**Features**

34" H x 17" W x 19" D
 18" Seat Height
 Solid Beech Hardwood
 Reinforced w/ Metal Brackets

Optional:

¾" Wood Seat (Add \$61.88 Grade 1)
 Cherry, Dark Mahogany,
 Mahogany, Walnut Frame

Quantity	Grade 1	Grade 2	Grade 3	Grade 4	Grade 5
150+	254.44	257.77	261.10	264.43	267.76
51 - 149	257.77	261.10	264.43	267.76	271.09
1 - 50	279.99	283.32	286.65	289.98	293.31

COM Yardage: ½ yd. - price @ GR 1

Weight: 18 lbs, Wood 20 lbs

Items Per Carton: 2

Shipping Class: 150



Horizontal 6 Stool

WLS - 1145 BS**Features**

44" H x 17" W x 19" D
 30" Seat Height
 Solid Beech Hardwood
 Reinforced w/ Metal Brackets

Optional:

¾" Wood Seat (Add \$61.88 Grade 1)
 Brass Footrest (Add \$11.83)
 Cherry, Dark Mahogany,
 Mahogany, Walnut Frame

Quantity	Grade 1	Grade 2	Grade 3	Grade 4	Grade 5
150+	327.77	331.10	334.43	337.76	341.09
51 - 149	331.10	334.43	337.76	341.09	344.42
1 - 50	353.32	356.65	359.98	363.31	366.64

COM Yardage: ½ yd. - price @ GR 1

Weight: 23 lbs, Wood 25 lbs

Items Per Carton: 1

Shipping Class: 150



Schoolhouse Chair

WLS - 180**Features**

35" H x 19" W x 21½" D
 18" Seat Height
 Solid Beech Hardwood
 Nylon Glide
 6 Standard Stains
 Wood Seat Only

Quantity

150+	170.20
51 - 149	173.87
1 - 50	198.31

COM Yardage: N/A

Weight: 20 lbs

Items Per Carton: 2

Shipping Class: 150



Schoolhouse Stool

WLS - 1180 BS**Features**

44" H x 17" W x 19" D
 30" Seat Height
 Solid Beech Hardwood
 Nylon Glide
 6 Standard Stains
 Wood Seat Only

Quantity

150+	208.92
51 - 149	212.59
1 - 50	237.03

COM Yardage: N/A

Weight: 25 lbs

Items Per Carton: 1

Shipping Class: 150

Optional:

Brass Footrest (Add \$11.83)

Standard Wood Finishes

Walnut

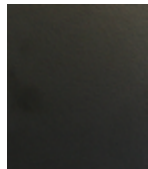

Black



Cherry



Dark Mahogany



Mahogany



Natural

* Finishes are reproduced as accurately as possible, colors may vary from actual product color.

To place your order

Ph: (478) 320-2502

Email: Jack@NewRetroDining.com



Latticeback Chair

WLS - 200**Features**

34" H x 16 1/2" W x 21" D
18" Seat Height
Solid Beech Hardwood
Nylon Glide
6 Standard Stains

Optional:

3/4" Wood Seat (Add \$61.88 Grade 1)

Quantity	Grade 1	Grade 2	Grade 3	Grade 4	Grade 5
150+	187.86	191.52	195.18	198.85	202.51
51 - 149	191.52	195.18	198.85	202.51	206.17
1 - 50	215.96	219.63	223.29	226.95	230.62

COM Yardage: 1/2 yd. - price @ GR 1

Items Per Carton: 2

Weight: 16 lbs, Wood 18 lbs

Shipping Class: 150



Latticeback Stool

WLS - 1200 BS**Features**

44" H x 16 1/2" W x 21" D
30" Seat Height
Solid Beech Hardwood
Nylon Glide
6 Standard Stains

Optional:

3/4" Wood Seat (Add \$61.88 Grade 1)
Brass Footrest (Add \$11.83)

Quantity	Grade 1	Grade 2	Grade 3	Grade 4	Grade 5
150+	226.58	230.24	233.90	237.57	241.23
51 - 149	230.24	233.90	237.57	241.23	244.89
1 - 50	254.68	258.35	262.01	265.67	269.34

COM Yardage: 1/2 yd. - price @ GR 1

Items Per Carton: 1

Weight: 21 lbs, Wood 23 lbs

Shipping Class: 150



Ladderback Chair

* Shown with optional wood seat

WLS - 300**Features**

32 1/2" H x 16 1/2" W x 20" D
18" Seat Height
Solid Beech Hardwood
Nylon Glide
6 Standard Stains

Optional:

3/4" Wood Seat (Add \$61.88 Grade 1)

Quantity	Grade 1	Grade 2	Grade 3	Grade 4	Grade 5
150+	180.10	183.77	187.43	191.09	194.76
51 - 149	183.77	187.43	191.09	194.76	198.42
1 - 50	208.21	211.87	215.53	219.20	222.86

COM Yardage: 1/2 yd. - price @ GR 1

Items Per Carton: 2

Weight: 16 lbs, Wood 18 lbs

Shipping Class: 150



Ladderback Stool

* Shown with optional wood seat

WLS - 1300 BS**Features**

42 1/2" H x 16" W x 19" D
30" Seat Height
Solid Beech Hardwood
Nylon Glide
6 Standard Stains

Optional:

3/4" Wood Seat (Add \$61.88 Grade 1)
Brass Footrest (Add \$11.83)

Quantity	Grade 1	Grade 2	Grade 3	Grade 4	Grade 5
150+	222.68	226.35	230.01	233.67	237.34
51 - 149	226.35	230.01	233.67	237.34	241.00
1 - 50	250.79	254.45	258.12	261.78	265.44

COM Yardage: 1/2 yd. - price @ GR 1

Items Per Carton: 1

Weight: 21 lbs, Wood 23 lbs

Shipping Class: 150

Minimum Quantity Shown For Each Item



Backless Stool

WLS - 1310 BS

Features

- 30" H x 16" W x 16" D
- 6 Standard Stains
- Wood Seat Only
- Non - Swivel

Quantity

7+	143.92
----	--------

COM Yardage: N/A

Weight: 16 lbs

Items Per Carton: 1

Shipping Class: 150

“Rule Of Thumb”

Chair & Table Space Requirements

- 14 sq. ft. per person for spacious dining — allows for table, chair and aisle.
- 12 sq. ft. per person for cafeteria or restaurant
- 10 sq. ft. per person for banquet, institutional or close seating.
- Allow 18" for person seated from edge of table to back of chair.
- Diagonal seating saves floor space — Deuce tables and wall spacing saves the most space.
- Allow 42" between squared tables for chairs back to back leaves 6" to push out.
- Allow 60" between squared tables for chairs back to back leaves 26" service aisle.
- Allow 24" between corners of diagonal tables for customer access — no aisle.
- Allow 30" between corners of diagonal tables for customer access — narrow aisle.
- Note:** Where space is limited, booths require only 8 sq. ft. per person including aisle allowance.

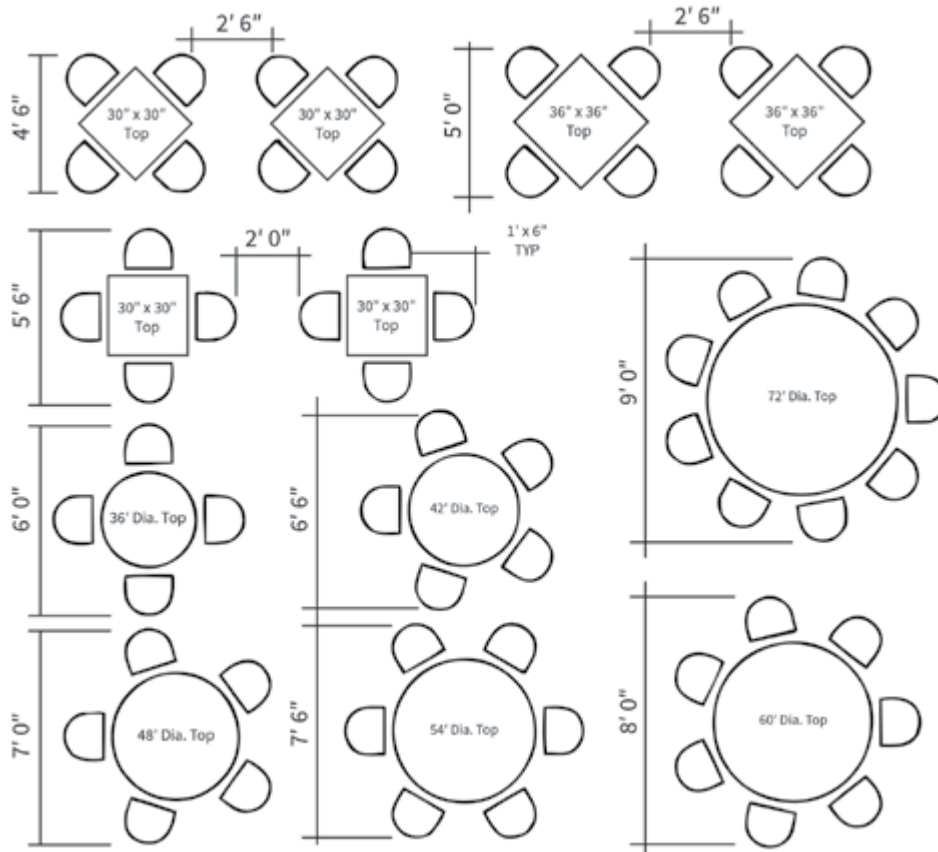

Legends

*All Legends Frames Are Painted Only



LSC - 250

Features

31" H x 18" W x 18" D
18" Seat Height
1 1/4" Pulled Seat
1 1/4" Sq. Steel Tubing (16 Gauge)
#18 Butyrate Heavy Duty Glide

Optional:

3/4" Wood Seat (Add \$61.88 Grade 1)

Quantity	Grade 1	Grade 2	Grade 3	Grade 4	Grade 5
100+	151.92	155.58	159.25	162.91	166.57
50 - 99	155.58	159.25	162.91	166.57	170.24
11 - 49	159.25	162.91	166.57	170.24	173.90
1 - 10	183.69	187.35	191.02	194.68	198.34

COM Yardage: 1/2 yd. - price @ GR 1
Items Per Carton: 2

Weight: 19 lbs, Wood 21 lbs
Shipping Class: 150



LSC - 1250 BS

Features

41" H x 18" W x 18" D
30" Seat Height
1 1/4" Pulled Seat
1 1/4" Sq. Steel Tubing (16 Gauge)
#18 Butyrate Heavy Duty Glide

Optional:

3/4" Wood Seat (Add \$61.88 Grade 1)
24" Seat Height (Add \$20.76)

Quantity	Grade 1	Grade 2	Grade 3	Grade 4	Grade 5
7+	197.64	201.30	204.96	208.63	212.29
1 - 6	222.08	225.74	229.41	233.07	236.73

COM Yardage: 1/2 yd. - price @ GR 1
Items Per Carton: 1

Weight: 25 lbs, Wood 27 lbs
Shipping Class: 150



600 - LSC - 250 BS

Features

41" H x 17" W x 18" D
1 1/4" Pulled Seat
1 1/4" Sq. Steel Tubing (16 Gauge)
#18 Butyrate Heavy Duty Glide
#20 DBL Plate Swivel

Optional:

3/4" Wood Seat (Add \$61.88 Grade 1)
24" or 30" Seat Height

Quantity	Grade 1	Grade 2	Grade 3	Grade 4	Grade 5
7+	326.03	329.69	333.35	337.01	340.67
1 - 6	350.53	354.19	357.85	361.52	365.18

COM Yardage: 1/2 yd. - price @ GR 1
Items Per Carton: 1

Weight: 30 lbs, Wood 32 lbs
Shipping Class: 150



1800 - LSC - 250 BS

Features

41" H x 17" W x 18" D
1 1/4" Pulled Seat
3" Sq. Column w/ Cast Iron Bottom
#22 DBL Plate Seat Return Swivel

Optional:

3/4" Wood Seat (Add \$61.88 Grade 1)
18", 24", or 30" Seat Height
Footrest (Shown is 606: Add \$89.91)

Quantity	Grade 1	Grade 2	Grade 3	Grade 4	Grade 5
7+	349.56	353.22	356.88	360.55	364.21
1 - 6	374.00	377.66	381.33	384.99	388.65

COM Yardage: 1/2 yd. - price @ GR 1
Items Per Carton: Varies

Weight: 36 lbs, Wood 38 lbs
Shipping Class: Head - 85, Base - 70

Specify Floor Attachment:
Type B (Wood)
Type C (Concrete)

*Footrest not available on 18"

Vertical Ladder Back

*All Legends Frames Are Painted Only



*Shown with optional wood seat

LSC - 350

Features

31" H x 18" W x 18" D
18" Seat Height
1 1/4" Pulled Seat
1 1/4" Sq. Steel Tubing (16 Gauge)
#18 Butyrate Heavy Duty Glide

Optional:

3/4" Wood Seat (Add \$61.88 Grade 1)

Quantity	Grade 1	Grade 2	Grade 3	Grade 4	Grade 5
100+	153.14	156.81	160.47	164.13	167.79
50 - 99	156.81	160.47	164.13	167.79	171.46
11 - 49	160.47	164.13	167.79	171.46	175.12
1 - 10	184.91	188.57	192.24	195.90	199.56

COM Yardage: 1/2 yd. - price @ GR 1

Items Per Carton: 2

Weight: 18 lbs, Wood 21 lbs

Shipping Class: 150



LSC - 1350 BS

Features

41" H x 18" W x 18" D
30" Seat Height
1 1/4" Pulled Seat
1 1/4" Sq. Steel Tubing (16 Gauge)
#18 Butyrate Heavy Duty Glide

Optional:

3/4" Wood Seat (Add \$61.88 Grade 1)

24" Seat Height (Add \$20.76)

Quantity	Grade 1	Grade 2	Grade 3	Grade 4	Grade 5
7+	215.80	219.46	223.12	226.79	230.45
1 - 6	240.24	243.90	247.57	251.23	254.89

COM Yardage: 1/2 yd. - price @ GR 1

Items Per Carton: 1

Weight: 25 lbs, Wood 27 lbs

Shipping Class: 150



600 - LSC - 350 BS

Features

41" H x 17" W x 18" D
1 1/4" Pulled Seat
1 1/4" Sq. Steel Tubing (16 Gauge)
#18 Butyrate Heavy Duty Glide
#20 DBL Plate Swivel

Optional:

3/4" Wood Seat (Add \$61.88 Grade 1)

24" or 30" Seat Height

Quantity	Grade 1	Grade 2	Grade 3	Grade 4	Grade 5
7+	331.46	335.13	338.79	342.45	346.12
1 - 6	355.91	359.57	363.23	366.89	370.56

COM Yardage: 1/2 yd. - price @ GR 1

Items Per Carton: 1

Weight: 30 lbs, Wood 32 lbs

Shipping Class: 150



1800 - LSC - 350 BS

Features

41" H x 17" W x 18" D
1 1/4" Pulled Seat
3" Sq. Column w/ Cast Iron Bottom
#22 DBL Plate Seat Return Swivel

Optional:

3/4" Wood Seat (Add \$61.88 Grade 1)

18", 24", or 30" Seat Height

Footrest (Shown is 606: Add \$89.91)

Quantity	Grade 1	Grade 2	Grade 3	Grade 4	Grade 5
7+	354.90	358.57	362.23	365.89	369.56
1 - 6	379.35	383.01	386.67	390.33	394.00

COM Yardage: 1/2 yd. - price @ GR 1

Items Per Carton: Varies

Weight: 36 lbs, Wood 38 lbs

Shipping Class: Head - 85, Base - 70

Specify Floor Attachment:

Type B (Wood)

Type C (Concrete)

*Footrest not available on 18"

Cross Strap Back

*All Legends Frames Are Painted Only



LSC - 450

Features

31" H x 18" W x 18" D
18" Seat Height
1 1/4" Pulled Seat
1 1/4" Sq. Steel Tubing (16 Gauge)
#18 Butyrate Heavy Duty Glide

Optional:

3/4" Wood Seat (Add \$61.88 Grade 1)

Quantity	Grade 1	Grade 2	Grade 3	Grade 4	Grade 5
100+	157.30	160.96	164.63	168.29	171.94
50 - 99	160.96	164.63	168.29	171.94	175.62
11 - 49	164.63	168.29	171.95	175.62	179.28
1 - 10	189.07	192.73	196.39	200.06	203.72

COM Yardage: 1/2 yd. - price @ GR 1
Items Per Carton: 2

Weight: 19 lbs, Wood 21 lbs
Shipping Class: 150



LSC - 1450 BS

Features

41" H x 18" W x 18" D
30" Seat Height
1 1/4" Pulled Seat
1 1/4" Sq. Steel Tubing (16 Gauge)
#18 Butyrate Heavy Duty Glide

Optional:

3/4" Wood Seat (Add \$61.88 Grade 1)
24" Seat Height (Add \$20.76)

Quantity	Grade 1	Grade 2	Grade 3	Grade 4	Grade 5
7+	213.76	217.43	221.09	224.75	228.42
1 - 6	238.21	241.87	245.53	249.19	252.86

COM Yardage: 1/2 yd. - price @ GR 1
Items Per Carton: 1

Weight: 25 lbs, Wood 27 lbs
Shipping Class: 150

* Shown with optional wood seat



600 - LSC - 450 BS

Features

41" H x 17" W x 18" D
1 1/4" Pulled Seat
1 1/4" Sq. Steel Tubing (16 Gauge)
#18 Butyrate Heavy Duty Glide
#20 DBL Plate Swivel

Optional:

3/4" Wood Seat (Add \$61.88 Grade 1)
24" or 30" Seat Height

Quantity	Grade 1	Grade 2	Grade 3	Grade 4	Grade 5
7+	339.50	343.17	346.83	350.49	354.16
1 - 6	363.95	367.61	371.27	374.94	378.60

COM Yardage: 1/2 yd. - price @ GR 1
Items Per Carton: 1

Weight: 30 lbs, Wood 32 lbs
Shipping Class: 150



1800 - LSC - 450 BS

Features

41" H x 17" W x 18" D
1 1/4" Pulled Seat
3" Sq. Column w/ Cast Iron Bottom
#22 DBL Plate Seat Return Swivel

Optional:

3/4" Wood Seat (Add \$61.88 Grade 1)
18", 24", or 30" Seat Height
Footrest (Shown is 606: Add \$89.91)

Quantity	Grade 1	Grade 2	Grade 3	Grade 4	Grade 5
7+	354.90	358.57	362.23	365.89	369.56
1 - 6	379.35	383.01	386.67	390.34	394.00

COM Yardage: 1/2 yd. - price @ GR 1
Items Per Carton: Varies

Weight: 36 lbs, Wood 38 lbs
Shipping Class: Head - 85, Base - 70

Specify Floor Attachment:
Type B (Wood)
Type C (Concrete)

*Footrest not available on 18"

Lattice Back

*All Legends Frames Are Painted Only



LSC - 475

Features

31" H x 18" W x 18" D
18" Seat Height
1 1/4" Pulled Seat
1 1/4" Sq. Steel Tubing (16 Gauge)
#18 Butyrate Heavy Duty Glide

Optional:

3/4" Wood Seat (Add \$61.88 Grade 1)

Quantity	Grade 1	Grade 2	Grade 3	Grade 4	Grade 5
100+	157.30	160.96	164.63	168.29	171.95
50 - 99	160.96	164.63	168.29	171.95	175.62
11 - 49	164.63	168.29	171.95	175.62	179.28
1 - 10	189.07	192.73	196.39	200.06	203.72

COM Yardage: 1/2 yd. - price @ GR 1
Items Per Carton: 2

Weight: 18lbs, Wood 21lbs
Shipping Class: 150



LSC - 1475 BS

Features

41" H x 18" W x 18" D
30" Seat Height
1 1/4" Pulled Seat
1 1/4" Sq. Steel Tubing (16 Gauge)
#18 Butyrate Heavy Duty Glide

Optional:

3/4" Wood Seat (Add \$61.88 Grade 1)
24" Seat Height (Add \$20.76)

Quantity	Grade 1	Grade 2	Grade 3	Grade 4	Grade 5
7+	213.76	217.43	221.09	224.75	228.42
1 - 6	238.21	241.87	245.53	249.19	252.88

COM Yardage: 1/2 yd. - price @ GR 1
Items Per Carton: 1

Weight: 25lbs, Wood 27lbs
Shipping Class: 150



600 - LSC - 475 BS

Features

41" H x 17" W x 18" D
1 1/4" Pulled Seat
1 1/4" Sq. Steel Tubing (16 Gauge)
#18 Butyrate Heavy Duty Glide
#20 DBL Plate Swivel

Optional:

3/4" Wood Seat (Add \$61.88 Grade 1)
24" or 30" Seat Height

Quantity	Grade 1	Grade 2	Grade 3	Grade 4	Grade 5
7+	339.50	343.17	346.83	350.49	354.16
1 - 6	363.95	367.61	371.27	374.94	378.60

COM Yardage: 1/2 yd. - price @ GR 1
Items Per Carton: 1

Weight: 30lbs, Wood 32lbs
Shipping Class: 150



1800 - LSC - 475 BS

Features

41" H x 17" W x 18" D
1 1/4" Pulled Seat
3" Sq. Column w/ Cast Iron Bottom
#22 DBL Plate Seat Return Swivel

Optional:

3/4" Wood Seat (Add \$61.88 Grade 1)
18", 24", or 30" Seat Height
Footrest (Shown on pg. 95)

Quantity	Grade 1	Grade 2	Grade 3	Grade 4	Grade 5
7+	354.90	358.57	362.23	365.89	369.56
1 - 6	379.35	383.01	386.67	390.34	394.00

COM Yardage: 1/2 yd. - price @ GR 1
Items Per Carton: Varies

Weight: 36lbs, Wood 38lbs
Shipping Class: Head - 85, Base - 70

Specify Floor Attachment:

Type B (Wood)
Type C (Concrete)

*Footrest not available on 18"

Slotted Moon Back

*All Legends Frames Are Painted Only *All Shown With Optional Wood Seat



LSC-501

Features

31" H x 18" W x 18" D
18" Seat Height
1 1/4" Pulled Seat
1 1/4" Sq. Steel Tubing (16 Gauge)
#18 Butyrate Heavy Duty Glide

Optional:

3/4" Wood Seat (Add \$61.88 Grade 1)

Quantity	Grade 1	Grade 2	Grade 3	Grade 4	Grade 5
100+	184.18	187.85	191.51	195.17	198.84
50 - 99	187.85	191.51	195.17	198.84	202.50
11 - 49	191.51	195.17	198.84	202.50	206.16
1 - 10	215.95	219.62	223.28	226.94	230.60

COM Yardage: 1/2 yd. - price @ GR 1
Items Per Carton: 2

Weight: 18 lbs, Wood 21 lbs
Shipping Class: 150



LSC-1501 BS

Features

41" H x 18" W x 18" D
30" Seat Height
1 1/4" Pulled Seat
1 1/4" Sq. Steel Tubing (16 Gauge)
#18 Butyrate Heavy Duty Glide

Optional:

3/4" Wood Seat (Add \$61.88 Grade 1)
24" Seat Height (Add \$20.76)

Quantity	Grade 1	Grade 2	Grade 3	Grade 4	Grade 5
7+	236.76	240.43	244.09	247.75	251.42
1 - 6	261.21	264.87	268.53	272.20	275.86

COM Yardage: 1/2 yd. - price @ GR 1
Items Per Carton: 1

Weight: 25 lbs, Wood 27 lbs
Shipping Class: 150



600-LSC-501 BS

Features

41" H x 17" W x 18" D
1 1/4" Pulled Seat
1 1/4" Sq. Steel Tubing (16 Gauge)
#18 Butyrate Heavy Duty Glide
#20 DBL Plate Swivel

Optional:

3/4" Wood Seat (Add \$61.88 Grade 1)
24" or 30" Seat Height

Quantity	Grade 1	Grade 2	Grade 3	Grade 4	Grade 5
7+	352.96	356.62	360.28	363.95	367.61
1 - 6	377.40	381.06	384.73	388.39	392.05

COM Yardage: 1/2 yd. - price @ GR 1
Items Per Carton: 1

Weight: 30 lbs, Wood 32 lbs
Shipping Class: 150



1800-LSC-501 BS

Features

41" H x 17" W x 18" D
1 1/4" Pulled Seat
3" Sq. Column w/ Cast Iron Bottom
#22 DBL Plate Seat Return Swivel

Optional:

3/4" Wood Seat (Add \$61.88 Grade 1)
18", 24", or 30" Seat Height
Footrest (Shown is 606: Add \$89.91)

Quantity	Grade 1	Grade 2	Grade 3	Grade 4	Grade 5
7+	381.82	385.48	389.15	392.81	396.47
1 - 6	406.26	409.93	413.59	417.25	420.92

COM Yardage: 1/2 yd. - price @ GR 1
Items Per Carton: Varies

Weight: 36 lbs, Wood 38 lbs
Shipping Class: Head - 85, Base - 70

Specify Floor Attachment:
Type B (Wood)
Type C (Concrete)

*Footrest not available on 18"

Wooden Moon Back

*All Legends Frames Are Painted Only



* Shown with optional wood seat

LSC - 550

Features

31" H x 18" W x 18" D
18" Seat Height
1 1/4" Pulled Seat
1 1/4" Sq. Steel Tubing (16 Gauge)
#18 Butyrate Heavy Duty Glide

Optional:

3/4" Wood Seat (Add \$61.88 Grade 1)

Quantity	Grade 1	Grade 2	Grade 3	Grade 4	Grade 5
100+	184.18	187.85	191.51	195.17	198.84
50 - 99	187.85	191.51	195.17	198.84	202.50
11 - 49	191.51	195.17	198.84	202.50	206.16
1 - 10	215.95	219.62	223.28	226.94	230.60

COM Yardage: 1/2 yd. - price @ GR 1
Items Per Carton: 2

Weight: 19lbs, Wood 21 lbs
Shipping Class: 150



* Shown with optional wood seat

LSC - 1550 BS

Features

41" H x 18" W x 18" D
30" Seat Height
1 1/4" Pulled Seat
1 1/4" Sq. Steel Tubing (16 Gauge)
#18 Butyrate Heavy Duty Glide

Optional:

3/4" Wood Seat (Add \$61.88 Grade 1)
24" Seat Height (Add \$20.76)

Quantity	Grade 1	Grade 2	Grade 3	Grade 4	Grade 5
7+	236.76	240.43	244.09	247.75	251.42
1 - 6	261.21	264.87	268.53	272.20	275.86

COM Yardage: 1/2 yd. - price @ GR 1
Items Per Carton: 1

Weight: 25lbs, Wood 27 lbs
Shipping Class: 150



600 - LSC - 550 BS

Features

41" H x 17" W x 18" D
1 1/4" Pulled Seat
1 1/4" Sq. Steel Tubing (16 Gauge)
#18 Butyrate Heavy Duty Glide
#20 DBL Plate Swivel

Optional:

3/4" Wood Seat (Add \$61.88 Grade 1)
24" or 30" Seat Height

Quantity	Grade 1	Grade 2	Grade 3	Grade 4	Grade 5
7+	352.96	356.62	360.28	363.95	367.61
1 - 6	377.40	381.06	384.73	388.39	392.05

COM Yardage: 1/2 yd. - price @ GR 1
Items Per Carton: 1

Weight: 30lbs, Wood 32 lbs
Shipping Class: 150



1800 - LSC - 550 BS

Features

41" H x 17" W x 18" D
1 1/4" Pulled Seat
3" Sq. Column w/ Cast Iron Bottom
#22 DBL Plate Seat Return Swivel

Optional:

3/4" Wood Seat (Add \$61.88 Grade 1)
18", 24", or 30" Seat Height
Footrest (Shown is 606: Add \$89.91)

Quantity	Grade 1	Grade 2	Grade 3	Grade 4	Grade 5
7+	381.82	385.48	389.15	392.81	396.47
1 - 6	406.26	409.93	413.59	417.25	420.92

COM Yardage: 1/2 yd. - price @ GR 1
Items Per Carton: Varies

Weight: 36lbs, Wood 38 lbs
Shipping Class: Head - 85, Base - 70

Specify Floor Attachment:

Type B (Wood)
Type C (Concrete)

*Footrest not available on 18"

Three Slotted Wood Back

*All Legends Frames Are Painted Only



* Shown with optional wood seat

LSC - 575

Features

31" H x 18" W x 18" D
18" Seat Height
1 1/4" Pulled Seat
1 1/4" Sq. Steel Tubing (16 Gauge)
#18 Butyrate Heavy Duty Glide

Optional:

3/4" Wood Seat (Add \$61.88 Grade 1)

Quantity	Grade 1	Grade 2	Grade 3	Grade 4	Grade 5
100+	184.18	187.85	191.51	195.17	198.84
50 - 99	187.85	191.51	195.17	198.84	202.50
11 - 49	191.51	195.17	198.84	202.50	206.16
1 - 10	215.95	219.62	223.28	226.94	230.60

COM Yardage: 1/2 yd. - price @ GR 1
Items Per Carton: 2

Weight: 19 lbs, Wood 21 lbs
Shipping Class: 150



* Shown with optional wood seat

LSC - 1575 BS

Features

41" H x 18" W x 18" D
30" Seat Height
1 1/4" Pulled Seat
1 1/4" Sq. Steel Tubing (16 Gauge)
#18 Butyrate Heavy Duty Glide

Optional:

3/4" Wood Seat (Add \$61.88 Grade 1)
24" Seat Height (Add \$20.76)

Quantity	Grade 1	Grade 2	Grade 3	Grade 4	Grade 5
7+	236.76	240.43	244.09	247.75	251.42
1 - 6	261.21	264.87	268.53	272.20	275.86

COM Yardage: 1/2 yd. - price @ GR 1
Items Per Carton: 1

Weight: 25 lbs, Wood 27 lbs
Shipping Class: 150



600 - LSC - 575 BS

Features

41" H x 17" W x 18" D
1 1/4" Pulled Seat
1 1/4" Sq. Steel Tubing (16 Gauge)
#18 Butyrate Heavy Duty Glide
#20 DBL Plate Swivel

Optional:

3/4" Wood Seat (Add \$61.88 Grade 1)
24" or 30" Seat Height

Quantity	Grade 1	Grade 2	Grade 3	Grade 4	Grade 5
7+	352.96	356.62	360.28	363.95	367.61
1 - 6	377.40	381.06	384.73	388.39	392.05

COM Yardage: 1/2 yd. - price @ GR 1
Items Per Carton: 1

Weight: 30 lbs, Wood 32 lbs
Shipping Class: 150



1800 - LSC - 575 BS

Features

41" H x 17" W x 18" D
1 1/4" Pulled Seat
3" Sq. Column w/ Cast Iron Bottom
#22 DBL Plate Seat Return Swivel

Optional:

3/4" Wood Seat (Add \$61.88 Grade 1)
18", 24", or 30" Seat Height
Footrest (Shown is 606: Add \$89.91)

Quantity	Grade 1	Grade 2	Grade 3	Grade 4	Grade 5
7+	381.82	385.48	389.15	392.81	396.47
1 - 6	406.26	409.93	413.59	417.25	420.92

COM Yardage: 1/2 yd. - price @ GR 1
Items Per Carton: Varies

Weight: 36 lbs, Wood 38 lbs
Shipping Class: Head - 85, Base - 70

Specify Floor Attachment:
Type B (Wood)
Type C (Concrete)

*Footrest not available on 18"

Five Slotted Wood Back

*All Legends Frames Are Painted Only



LSC - 600

Features

31" H x 18" W x 18" D
18" Seat Height
1 1/4" Pulled Seat
1 1/4" Sq. Steel Tubing (16 Gauge)
#18 Butyrate Heavy Duty Glide

Optional:

3/4" Wood Seat (Add \$61.88 Grade 1)

Quantity	Grade 1	Grade 2	Grade 3	Grade 4	Grade 5
100+	184.18	187.85	191.51	195.17	198.84
50 - 99	187.85	191.51	195.17	198.84	202.50
11 - 49	191.51	195.17	198.84	202.50	206.16
1 - 10	215.95	219.62	223.28	226.94	230.60

COM Yardage: 1/2 yd. - price @ GR 1
Items Per Carton: 2

Weight: 19lbs, Wood 21lbs
Shipping Class: 150



LSC - 1600 BS

Features

41" H x 18" W x 18" D
30" Seat Height
1 1/4" Pulled Seat
1 1/4" Sq. Steel Tubing (16 Gauge)
#18 Butyrate Heavy Duty Glide

Optional:

3/4" Wood Seat (Add \$61.88 Grade 1)
24" Seat Height (Add \$20.76)

Quantity	Grade 1	Grade 2	Grade 3	Grade 4	Grade 5
7+	236.76	240.43	244.09	247.75	251.42
1 - 6	261.21	264.87	268.53	272.20	275.86

COM Yardage: 1/2 yd. - price @ GR 1
Items Per Carton: 1

Weight: 25lbs, Wood 27lbs
Shipping Class: 150



600 - LSC - 600 BS

Features

41" H x 17" W x 18" D
1 1/4" Pulled Seat
1 1/4" Sq. Steel Tubing (16 Gauge)
#18 Butyrate Heavy Duty Glide
#20 DBL Plate Swivel

Optional:

3/4" Wood Seat (Add \$61.88 Grade 1)
24" or 30" Seat Height

Quantity	Grade 1	Grade 2	Grade 3	Grade 4	Grade 5
7+	352.96	356.62	360.28	363.95	367.61
1 - 6	377.40	381.06	384.73	388.39	392.05

COM Yardage: 1/2 yd. - price @ GR 1
Items Per Carton: 1

Weight: 30lbs, Wood 32lbs
Shipping Class: 150



1800 - LSC - 600 BS

Features

41" H x 17" W x 18" D
1 1/4" Pulled Seat
3" Sq. Column w/ Cast Iron Bottom
#22 DBL Plate Seat Return Swivel

Optional:

3/4" Wood Seat (Add \$61.88 Grade 1)
18", 24", or 30" Seat Height
Footrest (Shown is 606: Add \$89.91)

Quantity	Grade 1	Grade 2	Grade 3	Grade 4	Grade 5
7+	381.82	385.48	389.15	392.81	396.47
1 - 6	406.26	409.93	413.59	417.25	420.92

COM Yardage: 1/2 yd. - price @ GR 1
Items Per Carton: Varies

Weight: 36lbs, Wood 38lbs
Shipping Class: Head - 85, Base - 70

Specify Floor Attachment:

Type B (Wood)
Type C (Concrete)

*Footrest not available on 18"

Four Rung Ladder Back

*All Legends Frames Are Painted Only



LSC - 650

Features

31" H x 18" W x 18" D
18" Seat Height
1 1/4" Pulled Seat
1 1/4" Sq. Steel Tubing (16 Gauge)
#18 Butyrate Heavy Duty Glide

Optional:

3/4" Wood Seat (Add \$61.88 Grade 1)

Quantity	Grade 1	Grade 2	Grade 3	Grade 4	Grade 5
100+	163.12	166.78	170.45	174.11	177.77
50 - 99	166.78	170.45	174.11	177.77	181.43
11 - 49	170.45	174.11	177.77	181.43	185.10
1 - 10	194.89	198.55	202.21	205.88	209.54

COM Yardage: 1/2 yd. - price @ GR 1
Items Per Carton: 2

Weight: 20 lbs, Wood 22 lbs
Shipping Class: 150



LSC - 1650 BS

Features

41" H x 18" W x 18" D
30" Seat Height
1 1/4" Pulled Seat
1 1/4" Sq. Steel Tubing (16 Gauge)
#18 Butyrate Heavy Duty Glide

Optional:

3/4" Wood Seat (Add \$61.88 Grade 1)
24" Seat Height (Add \$20.76)

Quantity	Grade 1	Grade 2	Grade 3	Grade 4	Grade 5
7+	203.46	207.12	210.78	214.45	218.11
1 - 6	227.90	231.56	235.22	238.89	242.55

COM Yardage: 1/2 yd. - price @ GR 1
Items Per Carton: 1

Weight: 25 lbs, Wood 27 lbs
Shipping Class: 150



600 - LSC - 650 BS

Features

41" H x 17" W x 18" D
1 1/4" Pulled Seat
1 1/4" Sq. Steel Tubing (16 Gauge)
#18 Butyrate Heavy Duty Glide
#20 DBL Plate Swivel

Optional:

3/4" Wood Seat (Add \$61.88 Grade 1)
24" or 30" Seat Height

Quantity	Grade 1	Grade 2	Grade 3	Grade 4	Grade 5
7+	345.32	348.99	352.65	356.31	359.98
1 - 6	369.77	373.43	377.09	380.75	384.42

COM Yardage: 1/2 yd. - price @ GR 1
Items Per Carton: 1

Weight: 30 lbs, Wood 32 lbs
Shipping Class: 150



1800 - LSC - 650 BS

Features

41" H x 17" W x 18" D
1 1/4" Pulled Seat
3" Sq. Column w/ Cast Iron Bottom
#22 DBL Plate Seat Return Swivel

Optional:

3/4" Wood Seat (Add \$61.88 Grade 1)
18", 24", or 30" Seat Height
Footrest (Shown is 606: Add \$89.91)

Quantity	Grade 1	Grade 2	Grade 3	Grade 4	Grade 5
7+	360.68	364.34	368.01	371.67	375.33
1 - 6	385.12	388.78	392.45	396.11	399.77

COM Yardage: 1/2 yd. - price @ GR 1
Items Per Carton: Varies

Weight: 36 lbs, Wood 38 lbs
Shipping Class: Head - 85, Base - 70

Specify Floor Attachment:
Type B (Wood)
Type C (Concrete)

*Footrest not available on 18"

Three Rung Ladder Back

*All Legends Frames Are Painted Only *All Shown With Optional Wood Seat



LSC - 750

Features

31" H x 18" W x 18" D
18" Seat Height
1 1/4" Pulled Seat
1 1/4" Sq. Steel Tubing (16 Gauge)
#18 Butyrate Heavy Duty Glide

Optional:

3/4" Wood Seat (Add \$61.88 Grade 1)

Quantity	Grade 1	Grade 2	Grade 3	Grade 4	Grade 5
100+	157.74	161.40	165.07	168.73	172.39
50 - 99	161.40	165.07	168.73	172.39	176.06
11 - 49	165.07	168.73	172.39	176.06	179.72
1 - 10	189.51	193.17	196.83	200.50	204.16

COM Yardage: 1/2 yd. - price @ GR 1
Items Per Carton: 2

Weight: 19lbs, Wood 21lbs
Shipping Class: 150



LSC - 1750 BS

Features

41" H x 18" W x 18" D
30" Seat Height
1 1/4" Pulled Seat
1 1/4" Sq. Steel Tubing (16 Gauge)
#18 Butyrate Heavy Duty Glide

Optional:

3/4" Wood Seat (Add \$61.88 Grade 1)
24" Seat Height (Add \$20.76)

Quantity	Grade 1	Grade 2	Grade 3	Grade 4	Grade 5
7+	198.08	201.74	205.40	209.07	212.73
1 - 6	222.52	226.18	229.85	233.51	237.17

COM Yardage: 1/2 yd. - price @ GR 1
Items Per Carton: 1

Weight: 25lbs, Wood 27lbs
Shipping Class: 150



600 - LSC - 750 BS

Features

41" H x 17" W x 18" D
1 1/4" Pulled Seat
1 1/4" Sq. Steel Tubing (16 Gauge)
#18 Butyrate Heavy Duty Glide
#20 DBL Plate Swivel

Optional:

3/4" Wood Seat (Add \$61.88 Grade 1)
24" or 30" Seat Height

Quantity	Grade 1	Grade 2	Grade 3	Grade 4	Grade 5
7+	334.14	337.80	341.46	345.13	348.79
1 - 6	358.58	362.24	365.90	369.57	373.23

COM Yardage: 1/2 yd. - price @ GR 1
Items Per Carton: 1

Weight: 30lbs, Wood 32lbs
Shipping Class: 150



1800 - LSC - 750 BS

Features

41" H x 17" W x 18" D
1 1/4" Pulled Seat
3" Sq. Column w/ Cast Iron Bottom
#22 DBL Plate Seat Return Swivel

Optional:

3/4" Wood Seat (Add \$61.88 Grade 1)
18", 24", or 30" Seat Height
Footrest (Shown is 606: Add \$89.91)

Quantity	Grade 1	Grade 2	Grade 3	Grade 4	Grade 5
7+	355.18	358.84	362.51	366.17	369.83
1 - 6	379.62	383.28	386.95	390.61	394.27

COM Yardage: 1/2 yd. - price @ GR 1
Items Per Carton: Varies

Weight: 36lbs, Wood 38lbs
Shipping Class: Head - 85, Base - 70

Specify Floor Attachment:

Type B (Wood)
Type C (Concrete)

*Footrest not available on 18"

Oxford

*All Oxford Frames Are Painted Only

* $\frac{3}{4}$ " Wood Seat (Add \$61.88)



OX - 10

Features

34" H x 17" W x 18" D
18" Seat Height
1 $\frac{1}{4}$ " Pulled Seat
1 $\frac{1}{4}$ " Sq. Steel Tubing (16 Gauge)
Contoured Back w/ Button
#18 Butyrate Heavy Duty Glide

Quantity	Grade 1	Grade 2	Grade 3	Grade 4	Grade 5
100+	227.22	230.88	234.54	238.20	241.87
50 - 99	230.88	234.54	238.20	241.87	245.53
11 - 49	234.54	238.20	241.87	245.53	249.19
1 - 10	258.98	262.64	266.31	269.97	273.64

COM Yardage: 1 $\frac{2}{3}$ yds. - price @ GR 1
Items Per Carton: 2

Weight: 21 lbs, Wood 23 lbs
Shipping Class: 150



OX - 110 BS

Features

44" H x 17" W x 18" D
30" Seat Height
1 $\frac{1}{4}$ " Pulled Seat
1 $\frac{1}{4}$ " Sq. Steel Tubing (16 Gauge)
Contoured Back w/ Button
#18 Butyrate Heavy Duty Glide

Quantity	Grade 1	Grade 2	Grade 3	Grade 4	Grade 5
7+	280.98	284.65	288.31	291.97	295.64
1 - 6	305.43	309.09	312.75	316.42	320.08

COM Yardage: 1 $\frac{2}{3}$ yds. - price @ GR 1
Items Per Carton: 1

Weight: 30 lbs, Wood 32 lbs
Shipping Class: 150

Optional:

24" Seat Height (Add \$20.76)



600 - OX - 10 BS

Features

44" H x 17" W x 18" D
1 $\frac{1}{4}$ " Pulled Seat
1 $\frac{1}{4}$ " Sq. Steel Tubing (16 Gauge)
Contoured Back w/ Button
#18 Butyrate Heavy Duty Glide
#20 DBL Plate Swivel

Quantity	Grade 1	Grade 2	Grade 3	Grade 4	Grade 5
7+	399.28	402.94	406.60	410.27	413.93
1 - 6	423.72	427.38	431.05	434.71	438.37

COM Yardage: 1 $\frac{2}{3}$ yds. - price @ GR 1
Items Per Carton: 1

Weight: 30 lbs, Wood 32 lbs
Shipping Class: 150

Optional:

24" or 30" Seat Height



1800 - OX - 10 BS

Features

44" H x 17" W x 18" D
1 $\frac{1}{4}$ " Pulled Seat
3" Sq. Column w/ Cast Iron Bottom
#22 DBL Plate Seat Return Swivel

Quantity	Grade 1	Grade 2	Grade 3	Grade 4	Grade 5
7+	426.16	429.83	433.49	437.15	440.81
1 - 6	450.60	454.27	457.93	461.59	465.26

COM Yardage: 1 $\frac{2}{3}$ yds. - price @ GR 1
Items Per Carton: Varies

Weight: 36 lbs, Wood 38 lbs
Shipping Class: Head - 85, Base - 70

Optional:

$\frac{3}{4}$ " Wood Seat (Add \$61.88)
18", 24", or 30" Seat Height
Footrest (Shown is 606: Add \$89.91)

*Footrest not available on 18"

Round Back

*All Oxford Frames Are Painted Only

* $\frac{3}{4}$ " Wood Seat (Add \$61.88)



OX - 20

Features

35" H x 17" W x 18" D
18" Seat Height
1 $\frac{1}{4}$ " Pulled Seat
1 $\frac{1}{4}$ " Sq. Steel Tubing (16 Gauge)
Contoured Back
#18 Butyrate Heavy Duty Glide

Quantity	Grade 1	Grade 2	Grade 3	Grade 4	Grade 5
100+	227.22	230.88	234.54	238.20	241.87
50 - 99	230.88	234.54	238.20	241.87	245.53
11 - 49	234.54	238.20	241.87	245.53	249.19
1 - 10	258.98	262.64	266.31	269.97	273.64

COM Yardage: 1 $\frac{1}{3}$ yds. - price @ GR 1
Items Per Carton: 2

Weight: 21 lbs, Wood 23 lbs
Shipping Class: 150



OX - 120 BS

Features

45" H x 17" W x 18" D
30" Seat Height
1 $\frac{1}{4}$ " Pulled Seat
1 $\frac{1}{4}$ " Sq. Steel Tubing (16 Gauge)
Contoured Back
#18 Butyrate Heavy Duty Glide

Quantity	Grade 1	Grade 2	Grade 3	Grade 4	Grade 5
7+	280.98	284.65	288.31	291.97	295.64
1 - 6	305.43	309.09	312.75	316.42	320.08

COM Yardage: 1 $\frac{1}{3}$ yds. - price @ GR 1
Items Per Carton: 1

Weight: 30 lbs, Wood 32 lbs
Shipping Class: 150

Optional:

24" Seat Height (Add \$20.76)



600 - OX - 20 BS

Features

45" H x 17" W x 18" D
1 $\frac{1}{4}$ " Pulled Seat
1 $\frac{1}{4}$ " Sq. Steel Tubing (16 Gauge)
Contoured Back
#18 Butyrate Heavy Duty Glide
#20 DBL Plate Swivel

Quantity	Grade 1	Grade 2	Grade 3	Grade 4	Grade 5
7+	399.28	402.94	406.60	410.27	413.93
1 - 6	423.72	427.38	431.05	434.71	438.37

COM Yardage: 1 $\frac{1}{3}$ yds. - price @ GR 1
Items Per Carton: 1

Weight: 30 lbs, Wood 32 lbs
Shipping Class: 150

Optional:

24" or 30" Seat Height



1800 - OX - 20 BS

Features

45" H x 17" W x 18" D
1 $\frac{1}{4}$ " Pulled Seat
3" Sq. Column w/ Cast Iron Bottom
#22 DBL Plate Seat Return Swivel

Quantity	Grade 1	Grade 2	Grade 3	Grade 4	Grade 5
7+	426.16	429.83	433.49	437.15	440.81
1 - 6	450.60	454.27	457.93	461.59	465.26

COM Yardage: 1 $\frac{1}{3}$ yds. - price @ GR 1
Items Per Carton: Varies

Weight: 36 lbs, Wood 38 lbs
Shipping Class: Head - 85, Base - 70

Optional:

$\frac{3}{4}$ " Wood Seat (Add \$61.88)
18", 24", or 30" Seat Height
Footrest (Shown is 606: Add \$89.91)

*Footrest not available on 18"

Channel Back

* All Oxford Frames Are Painted Only

* ¾" Wood Seat (Add \$61.88)



OX - 30

Features

34" H x 17" W x 18" D
18" Seat Height
1¼" Pulled Seat
1¼" Sq. Steel Tubing (16 Gauge)
Contoured Back w/ Channels
#18 Butyrate Heavy Duty Glide

Quantity	Grade 1	Grade 2	Grade 3	Grade 4	Grade 5
100+	227.22	230.88	234.54	238.20	241.87
50 – 99	230.88	234.54	238.20	241.87	245.53
11 – 49	234.54	238.20	241.87	245.53	249.19
1 – 10	258.98	262.64	266.31	269.97	273.64

COM Yardage: 1⅓ yds. - price @ GR 1
Items Per Carton: 2

Weight: 21 lbs, Wood 23 lbs
Shipping Class: 150



OX - 130 BS

Features

44" H x 17" W x 18" D
30" Seat Height
1¼" Pulled Seat
1¼" Sq. Steel Tubing (16 Gauge)
Contoured Back w/ Channels
#18 Butyrate Heavy Duty Glide

Quantity	Grade 1	Grade 2	Grade 3	Grade 4	Grade 5
7+	280.98	284.65	288.31	291.97	295.64
1 – 6	305.43	309.09	312.75	316.42	320.08

COM Yardage: 1⅓ yds. - price @ GR 1
Items Per Carton: 1

Weight: 30 lbs, Wood 32 lbs
Shipping Class: 150

Optional:

24" Seat Height (Add \$20.76)



600 - OX - 30 BS

Features

44" H x 17" W x 18" D
1¼" Pulled Seat
1¼" Sq. Steel Tubing (16 Gauge)
Contoured Back w/ Channels
#18 Butyrate Heavy Duty Glide
#20 DBL Plate Swivel

Quantity	Grade 1	Grade 2	Grade 3	Grade 4	Grade 5
7+	399.28	402.94	406.60	410.27	413.93
1 – 6	423.72	427.38	431.05	434.71	438.37

COM Yardage: 1⅓ yds. - price @ GR 1
Items Per Carton: 1

Weight: 30 lbs, Wood 32 lbs
Shipping Class: 150

Optional:

24" or 30" Seat Height



1800 - OX - 30 BS

Features

44" H x 17" W x 18" D
1¼" Pulled Seat
3" Sq. Column w/ Cast Iron Bottom
#22 DBL Plate Seat Return Swivel

Quantity	Grade 1	Grade 2	Grade 3	Grade 4	Grade 5
7+	426.16	429.83	433.49	437.15	440.81
1 – 6	450.60	454.27	457.93	461.59	465.26

COM Yardage: 1⅓ yds. - price @ GR 1
Items Per Carton: Varies

Weight: 36 lbs, Wood 38 lbs
Shipping Class: Head - 85, Base - 70

Optional:

¾" Wood Seat (Add \$61.88)
18", 24", or 30" Seat Height

*Footrest not available on 18"

Banana Back

*All Oxford Frames Are Painted Only

* $\frac{3}{4}$ " Wood Seat (Add \$61.88)



OX - 40

Features

33" H x 17" W x 18" D
18" Seat Height
1 $\frac{1}{4}$ " Pulled Seat
1 $\frac{1}{4}$ " Sq. Steel Tubing (16 Gauge)
Contoured Back
#18 Butyrate Heavy Duty Glide

Quantity	Grade 1	Grade 2	Grade 3	Grade 4	Grade 5
100+	182.84	186.51	190.17	193.83	197.49
50 - 99	186.51	190.17	193.83	197.49	201.16
11 - 49	190.17	193.83	197.49	201.16	204.82
1 - 10	214.61	218.27	221.94	225.60	229.26

COM Yardage: 1 $\frac{1}{8}$ yds. - price @ GR 1
Items Per Carton: 2

Weight: 21 lbs, Wood 23 lbs
Shipping Class: 150



OX - 140 BS

Features

43" H x 17" W x 18" D
30" Seat Height
1 $\frac{1}{4}$ " Pulled Seat
1 $\frac{1}{4}$ " Sq. Steel Tubing (16 Gauge)
Contoured Back
#18 Butyrate Heavy Duty Glide

Quantity	Grade 1	Grade 2	Grade 3	Grade 4	Grade 5
7+	231.24	234.91	238.57	242.23	245.89
1 - 6	255.68	259.35	263.01	266.67	270.34

COM Yardage: 1 $\frac{1}{8}$ yds. - price @ GR 1
Items Per Carton: 1

Weight: 30 lbs, Wood 32 lbs
Shipping Class: 150

Optional:

24" Seat Height (Add \$20.76)



600 - OX - 40 BS

Features

43" H x 17" W x 18" D
1 $\frac{1}{4}$ " Pulled Seat
1 $\frac{1}{4}$ " Sq. Steel Tubing (16 Gauge)
Contoured Back
#18 Butyrate Heavy Duty Glide
#20 DBL Plate Swivel

Quantity	Grade 1	Grade 2	Grade 3	Grade 4	Grade 5
7+	350.88	354.55	358.20	361.87	365.53
1 - 6	375.32	378.98	382.65	386.31	389.97

COM Yardage: 1 $\frac{1}{8}$ yds. - price @ GR 1
Items Per Carton: 1

Weight: 30 lbs, Wood 32 lbs
Shipping Class: 150

Optional:

24" or 30" Seat Height



1800 - OX - 40 BS

Features

43" H x 17" W x 18" D
1 $\frac{1}{4}$ " Pulled Seat
3" Sq. Column w/ Cast Iron Bottom
#22 DBL Plate Seat Return Swivel

Quantity	Grade 1	Grade 2	Grade 3	Grade 4	Grade 5
7+	377.76	381.43	385.09	388.75	392.41
1 - 6	402.20	405.87	409.53	413.19	416.86

COM Yardage: 1 $\frac{1}{8}$ yds. - price @ GR 1
Items Per Carton: Varies

Weight: 36 lbs, Wood 38 lbs
Shipping Class: Head - 85, Base - 70

Optional:

$\frac{3}{4}$ " Wood Seat (Add \$61.88)

18", 24", or 30" Seat Height

*Footrest not available on 18"

Specify Floor Attachment:

Type B (Wood)

Type C (Concrete)

Sled Back

*All Oxford Frames Are Painted Only

* $\frac{3}{4}$ " Wood Seat (Add \$61.88)



OX - 50

Features

33" H x 17" W x 18" D
18" Seat Height
1 $\frac{1}{4}$ " Pulled Seat
1 $\frac{1}{4}$ " Sq. Steel Tubing (16 Gauge)
Contoured Back
#18 Butyrate Heavy Duty Glide

Quantity	Grade 1	Grade 2	Grade 3	Grade 4	Grade 5
100+	182.84	186.51	190.17	193.83	197.49
50 - 99	186.51	190.17	193.83	197.49	201.16
11 - 49	190.17	193.83	197.49	201.16	204.82
1 - 10	214.61	218.27	221.94	225.60	229.26

COM Yardage: 1 $\frac{1}{3}$ yds. - price @ GR 1
Items Per Carton: 2

Weight: 21 lbs, Wood 23 lbs
Shipping Class: 150



OX - 150 BS

Features

43" H x 17" W x 18" D
30" Seat Height
1 $\frac{1}{4}$ " Pulled Seat
1 $\frac{1}{4}$ " Sq. Steel Tubing (16 Gauge)
Contoured Back
#18 Butyrate Heavy Duty Glide

Quantity	Grade 1	Grade 2	Grade 3	Grade 4	Grade 5
7+	231.24	234.91	238.57	242.23	245.89
1 - 6	255.68	259.35	263.01	266.67	270.34

COM Yardage: 1 $\frac{1}{3}$ yds. - price @ GR 1
Items Per Carton: 1

Weight: 30 lbs, Wood 32 lbs
Shipping Class: 150

Optional:

24" Seat Height (Add \$20.76)



600 - OX - 50 BS

Features

43" H x 17" W x 18" D
1 $\frac{1}{4}$ " Pulled Seat
1 $\frac{1}{4}$ " Sq. Steel Tubing (16 Gauge)
Contoured Back
#18 Butyrate Heavy Duty Glide
#20 DBL Plate Swivel

Quantity	Grade 1	Grade 2	Grade 3	Grade 4	Grade 5
7+	350.88	354.55	358.20	361.87	365.53
1 - 6	375.32	378.98	382.65	386.31	389.97

COM Yardage: 1 $\frac{1}{3}$ yds. - price @ GR 1
Items Per Carton: 1

Weight: 30 lbs, Wood 32 lbs
Shipping Class: 150

Optional:

24" or 30" Seat Height



1800 - OX - 50 BS

Features

44" H x 17" W x 18" D
1 $\frac{1}{4}$ " Pulled Seat
3" Sq. Column w/ Cast Iron Bottom
#22 DBL Plate Seat Return Swivel

Quantity	Grade 1	Grade 2	Grade 3	Grade 4	Grade 5
7+	377.76	381.43	385.09	388.75	392.41
1 - 6	402.20	405.87	409.53	413.19	416.86

COM Yardage: 1 $\frac{1}{3}$ yds. - price @ GR 1
Items Per Carton: Varies

Weight: 36 lbs, Wood 38 lbs
Shipping Class: Head - 85, Base - 70

Optional:

$\frac{3}{4}$ " Wood Seat (Add \$61.88)
18", 24", or 30" Seat Height
Footrest (Shown is 606: Add \$89.91)

*Footrest not available on 18"

Plain Back

*All Oxford Frames Are Painted Only

* $\frac{3}{4}$ " Wood Seat (Add \$61.88)



OX - 60

Features

32" H x 17" W x 18" D
18" Seat Height
1 $\frac{1}{4}$ " Pulled Seat
1 $\frac{1}{4}$ " Sq. Steel Tubing (16 Gauge)
Contoured Back
#18 Butyrate Heavy Duty Glide

Quantity	Grade 1	Grade 2	Grade 3	Grade 4	Grade 5
100+	182.84	186.51	190.17	193.83	197.49
50 - 99	186.51	190.17	193.83	197.49	201.16
11 - 49	190.17	193.83	197.49	201.16	204.82
1 - 10	214.61	218.27	221.94	225.60	229.26

COM Yardage: 1 yd. - price @ GR 1
Items Per Carton: 2

Weight: 21 lbs, Wood 23 lbs
Shipping Class: 150



OX - 160 BS

Features

41" H x 17" W x 18" D
30" Seat Height
1 $\frac{1}{4}$ " Pulled Seat
1 $\frac{1}{4}$ " Sq. Steel Tubing (16 Gauge)
Contoured Back
#18 Butyrate Heavy Duty Glide

Quantity	Grade 1	Grade 2	Grade 3	Grade 4	Grade 5
7+	231.24	234.91	238.57	242.23	245.89
1 - 6	255.68	259.35	263.01	266.67	270.34

COM Yardage: 1 yd. - price @ GR 1
Items Per Carton: 1

Weight: 30 lbs, Wood 32 lbs
Shipping Class: 150

Optional:

24" Seat Height (Add \$20.76)



600 - OX - 60 BS

Features

41" H x 17" W x 18" D
1 $\frac{1}{4}$ " Pulled Seat
1 $\frac{1}{4}$ " Sq. Steel Tubing (16 Gauge)
Contoured Back
#18 Butyrate Heavy Duty Glide
#20 DBL Plate Swivel

Quantity	Grade 1	Grade 2	Grade 3	Grade 4	Grade 5
7+	350.88	354.55	358.20	361.87	365.53
1 - 6	375.32	378.98	382.65	386.31	389.97

COM Yardage: 1 yd. - price @ GR 1
Items Per Carton: 1

Weight: 30 lbs, Wood 32 lbs
Shipping Class: 150

Optional:

24" or 30" Seat Height



1800 - OX - 60 BS

Features

41" H x 17" W x 18" D
1 $\frac{1}{4}$ " Pulled Seat
3" Sq. Column w/ Cast Iron Bottom
#22 DBL Plate Seat Return Swivel

Quantity	Grade 1	Grade 2	Grade 3	Grade 4	Grade 5
7+	377.76	381.43	385.09	388.75	392.41
1 - 6	402.20	405.87	409.53	413.19	416.86

COM Yardage: 1 yd. - price @ GR 1
Items Per Carton: Varies

Weight: 36 lbs, Wood 38 lbs
Shipping Class: Head - 85, Base - 70

Optional:

$\frac{3}{4}$ " Wood Seat (Add \$61.88)

18", 24", or 30" Seat Height

*Footrest not available on 18"

Specify Floor Attachment:

Type B (Wood)

Type C (Concrete)

Omni & Spectrum



Stacking Channel Back Chair

SCB - PS

Features

37" H x 20" W x 20" D
18" Seat Height
1½" Thick Seat
1¼" Rd. Steel Tubing (16 Gauge)
#15 Platform Glide
Stacks 6 High

Quantity	Grade 1	Grade 2	Grade 3	Grade 4	Grade 5
100+	196.98	200.64	204.30	207.97	211.63
50 - 99	200.64	204.30	207.97	211.63	215.29
11 - 49	204.30	207.97	211.63	215.29	218.96
1 - 10	228.75	232.41	236.07	239.73	243.40

COM Yardage: 1⅓ yds. - price @ GR 1
Items Per Carton: 4

Weight: 25 lbs
Shipping Class: 150



Channel Back Stool

CBBS - PS

Features

46" H x 17½" W x 20" D
30" Seat Height
1½" Thick Seat
1¼" Rd. Steel Tubing (16 Gauge)
#15 Platform Glide
Optional:
24" Seat Height (Add \$20.76)

Quantity	Grade 1	Grade 2	Grade 3	Grade 4	Grade 5
7+	256.11	259.78	263.44	267.10	270.77
1 - 6	280.56	284.22	287.88	291.54	295.21

COM Yardage: 1⅓ yds. - price @ GR 1
Items Per Carton: 1

Weight: 31 lbs
Shipping Class: 150



Double Slat Chair

DS - PS

Features

37" H x 17½" W x 20" D
18" Seat Height
1½" Thick Seat
1¼" Rd. Steel Tubing (16 Gauge)
#15 Platform Glide

Quantity	Grade 1	Grade 2	Grade 3	Grade 4	Grade 5
100+	142.42	146.08	149.74	153.41	157.07
50 - 99	146.08	149.74	153.41	157.07	160.73
11 - 49	149.74	153.41	157.07	160.73	164.40
1 - 10	174.19	177.85	181.51	185.17	188.84

COM Yardage: ⅔ yd. - price @ GR 1
Items Per Carton: 2

Weight: 20 lbs
Shipping Class: 150



Double Slat Stool

DSBS - PS

Features

46" H x 17½" W x 20" D
30" Seat Height
1½" Thick Seat
1¼" Rd. Steel Tubing (16 Gauge)
#15 Platform Glide
Optional:
24" Seat Height (Add \$20.76)

Quantity	Grade 1	Grade 2	Grade 3	Grade 4	Grade 5
7+	207.42	211.08	214.74	218.41	222.07
1 - 6	231.86	235.52	239.18	242.85	246.51

COM Yardage: ⅔ yd. - price @ GR 1
Items Per Carton: 1

Weight: 30 lbs
Shipping Class: 150



Fanback Chair

FB - PS**Features**

37" H x 17½" W x 20" D
 18" Seat Height
 1½" Thick Seat
 1¼" Rd. Steel Tubing (16 Gauge)
 #15 Platform Glide

Quantity	Grade 1	Grade 2	Grade 3	Grade 4	Grade 5
100+	120.68	124.34	128.01	131.67	135.33
50 – 99	124.34	128.01	131.67	135.33	139.00
11 – 49	128.01	131.67	135.33	139.00	142.66
1 – 10	152.45	156.11	159.78	163.44	167.10

COM Yardage: ⅔ yd. - price @ GR 1

Weight: 20 lbs

Items Per Carton: 2

Shipping Class: 150



Stacking Fanback Chair

SFB - PS**Features**

37" H x 20" W x 20" D
 18" Seat Height
 1½" Thick Seat
 1¼" Rd. Steel Tubing (16 Gauge)
 #15 Platform Glide
 Stacks 6 High

Quantity	Grade 1	Grade 2	Grade 3	Grade 4	Grade 5
100+	148.74	152.41	156.07	159.73	163.39
50 – 99	152.41	156.07	159.73	163.39	167.06
11 – 49	156.07	159.73	163.39	167.06	170.72
1 – 10	180.51	184.17	187.84	191.50	195.16

COM Yardage: ⅔ yd. - price @ GR 1

Weight: 25 lbs

Items Per Carton: 4

Shipping Class: 150



Fanback Stool

FBBS - PS**Features**

46" H x 17½" W x 20" D
 30" Seat Height
 1½" Thick Seat
 1¼" Rd. Steel Tubing (16 Gauge)
 #15 Platform Glide

Quantity	Grade 1	Grade 2	Grade 3	Grade 4	Grade 5
7+	207.42	211.08	214.74	218.41	222.07
1 – 6	231.86	235.52	239.18	242.85	246.51

COM Yardage: ⅔ yd. - price @ GR 1

Weight: 30 lbs

Items Per Carton: 1

Shipping Class: 150

Optional:

24" Seat Height (Add \$20.76)



Hourglass Chair

HG - PS**Features**

37" H x 17½" W x 20" D
 18" Seat Height
 1½" Thick Seat
 1¼" Rd. Steel Tubing (16 Gauge)
 #15 Platform Glide

Quantity	Grade 1	Grade 2	Grade 3	Grade 4	Grade 5
100+	206.32	209.98	213.64	217.31	220.97
50 – 99	209.98	213.64	217.31	220.97	224.63
11 – 49	213.64	217.31	220.97	224.63	228.29
1 – 10	238.08	241.75	245.41	249.07	252.74

COM Yardage: 1½ yds. - price @ GR 1

Weight: 24 lbs

Items Per Carton: 2

Shipping Class: 150



Hourglass Stool

HGBS - PS**Features**

46" H x 17½" W x 20" D
 30" Seat Height
 1½" Thick Seat
 1¼" Rd. Steel Tubing (16 Gauge)
 #15 Platform Glide

Optional:

24" Seat Height (Add \$20.76)

Quantity	Grade 1	Grade 2	Grade 3	Grade 4	Grade 5
7+	258.20	261.87	265.53	269.19	272.86
1 - 6	282.65	286.31	289.97	293.63	297.30

COM Yardage: 1⅓ yds. - price @ GR 1

Weight: 32 lbs

Items Per Carton: 1

Shipping Class: 150



Hairpin Chair

HP - PS**Features**

37" H x 17½" W x 20" D
 18" Seat Height
 1½" Thick Seat
 1¼" Rd. Steel Tubing (16 Gauge)
 #15 Platform Glide

Quantity	Grade 1	Grade 2	Grade 3	Grade 4	Grade 5
100+	143.30	146.96	150.62	154.29	157.95
50 - 99	146.96	150.62	154.29	157.95	161.61
11 - 49	150.62	154.29	157.95	161.61	165.28
1 - 10	175.07	178.73	182.39	186.05	189.72

COM Yardage: ⅔ yd. - price @ GR 1

Weight: 20 lbs

Items Per Carton: 2

Shipping Class: 150



Hairpin Stool

HPBS - PS**Features**

46" H x 17½" W x 20" D
 30" Seat Height
 1½" Thick Seat
 1¼" Rd. Steel Tubing (16 Gauge)
 #15 Platform Glide

Optional:

24" Seat Height (Add \$20.76)

Quantity	Grade 1	Grade 2	Grade 3	Grade 4	Grade 5
7+	207.42	211.08	214.74	218.41	222.07
1 - 6	231.86	235.52	239.18	242.85	246.51

COM Yardage: ⅔ yd. - price @ GR 1

Weight: 30 lbs

Items Per Carton: 1

Shipping Class: 150



Inverted "T" Chair

IT - PS**Features**

37" H x 17½" W x 20" D
 18" Seat Height
 1½" Thick Seat
 1¼" Rd. Steel Tubing (16 Gauge)
 #15 Platform Glide

Quantity	Grade 1	Grade 2	Grade 3	Grade 4	Grade 5
100+	196.34	200.00	203.67	207.33	210.99
50 - 99	200.00	203.67	207.33	210.99	214.65
11 - 49	203.67	207.33	210.99	214.65	218.32
1 - 10	228.11	231.77	235.43	239.10	242.76

COM Yardage: 1⅓ yds. - price @ GR 1

Weight: 22 lbs

Items Per Carton: 2

Shipping Class: 150



Inverted "T" Stool

ITBS - PS**Features**

46" H x 17½" W x 20" D
 30" Seat Height
 1½" Thick Seat
 1¼" Rd. Steel Tubing (16 Gauge)
 #15 Platform Glide

Optional:

24" Seat Height (Add \$20.76)

Quantity	Grade 1	Grade 2	Grade 3	Grade 4	Grade 5
7+	237.26	240.92	244.59	248.25	251.91
1-6	261.70	265.36	269.03	272.69	276.35

COM Yardage: 1⅓ yds. - price @ GR 1

Weight: 32lbs

Items Per Carton: 1

Shipping Class: 150



Mushroom Chair

MR - PS**Features**

37" H x 17½" W x 20" D
 18" Seat Height
 1½" Thick Seat
 1¼" Rd. Steel Tubing (16 Gauge)
 #15 Platform Glide

Quantity	Grade 1	Grade 2	Grade 3	Grade 4	Grade 5
100+	194.58	198.24	201.91	205.57	209.23
50-99	198.24	201.91	205.57	209.23	212.89
11-49	201.91	205.57	209.23	212.89	216.56
1-10	226.35	230.01	233.67	237.34	241.00

COM Yardage: 1⅓ yds. - price @ GR 1

Weight: 22lbs

Items Per Carton: 2

Shipping Class: 150



Stacking Mushroom Chair

SMR - PS**Features**

37" H x 20" W x 20" D
 18" Seat Height
 1½" Thick Seat
 1¼" Rd. Steel Tubing (16 Gauge)
 #15 Platform Glide
 Stacks 6 High

Quantity	Grade 1	Grade 2	Grade 3	Grade 4	Grade 5
100+	184.18	187.85	191.51	195.17	198.84
50-99	187.85	191.51	195.17	198.84	202.50
11-49	191.51	195.17	198.84	202.50	206.16
1-10	215.95	219.62	223.28	226.94	230.60

COM Yardage: 1⅓ yds. - price @ GR 1

Weight: 25 lbs

Items Per Carton: 4

Shipping Class: 150



Mushroom Stool

MRBS - PS**Features**

46" H x 17½" W x 20" D
 30" Seat Height
 1½" Thick Seat
 1¼" Rd. Steel Tubing (16 Gauge)
 #15 Platform Glide

Optional:

24" Seat Height (Add \$20.76)

Quantity	Grade 1	Grade 2	Grade 3	Grade 4	Grade 5
7+	246.40	250.06	253.73	257.39	261.05
1-6	270.84	274.51	278.17	281.83	285.49

COM Yardage: 1⅓ yds. - price @ GR 1

Weight: 31 lbs

Items Per Carton: 1

Shipping Class: 150



Plain Back Chair

PB - PS**Features**

37" H x 17½" W x 20" D
 18" Seat Height
 1½" Thick Seat
 1¼" Rd. Steel Tubing (16 Gauge)
 #15 Platform Glide

Quantity	Grade 1	Grade 2	Grade 3	Grade 4	Grade 5
100+	206.32	209.98	213.64	217.31	220.97
50 – 99	209.98	213.64	217.31	220.97	224.63
11 – 49	213.64	217.31	220.97	224.63	228.29
1 – 10	238.08	241.75	245.41	249.07	252.74

COM Yardage: 1⅓ yds. - price @ GR 1
 Items Per Carton: 2

Weight: 25 lbs
 Shipping Class: 150



Plain Back Stool

PBBS - PS**Features**

46" H x 17½" W x 20" D
 30" Seat Height
 1½" Thick Seat
 1¼" Rd. Steel Tubing (16 Gauge)
 #15 Platform Glide

Quantity	Grade 1	Grade 2	Grade 3	Grade 4	Grade 5
7+	258.16	261.82	265.49	269.15	272.81
1 – 6	282.60	286.26	289.93	293.59	297.25

COM Yardage: 1⅓ yds. - price @ GR 1
 Items Per Carton: 1

Weight: 32 lbs
 Shipping Class: 150

Optional:

24" Seat Height (Add \$20.76)



Round Back Chair

RB - PS**Features**

37" H x 17½" W x 20" D
 18" Seat Height
 1½" Thick Seat
 1¼" Rd. Steel Tubing (16 Gauge)
 #15 Platform Glide

Quantity	Grade 1	Grade 2	Grade 3	Grade 4	Grade 5
100+	196.16	199.83	203.49	207.15	210.82
50 – 99	199.83	203.49	207.15	210.82	214.48
11 – 49	203.49	207.15	210.82	214.48	218.14
1 – 10	227.93	231.59	235.26	238.92	242.58

COM Yardage: 1⅓ yds. - price @ GR 1
 Items Per Carton: 2

Weight: 21 lbs
 Shipping Class: 150



Round Back Stool

RBBS - PS**Features**

46" H x 17½" W x 20" D
 30" Seat Height
 1½" Thick Seat
 1¼" Rd. Steel Tubing (16 Gauge)
 #15 Platform Glide

Quantity	Grade 1	Grade 2	Grade 3	Grade 4	Grade 5
7+	243.02	246.69	250.35	254.01	257.68
1 – 6	267.47	271.13	274.79	278.45	282.12

COM Yardage: 1⅓ yds. - price @ GR 1
 Items Per Carton: 1

Weight: 31 lbs
 Shipping Class: 150

Optional:

24" Seat Height (Add \$20.76)



Stacking Smooth Back Chair

SSB - PS**Features**

37" H x 20" W x 20" D
 18" Seat Height
 1½" Thick Seat
 1¼" Rd. Steel Tubing (16 Gauge)
 #15 Platform Glide
 Stacks 6 High

Quantity	Grade 1	Grade 2	Grade 3	Grade 4	Grade 5
100+	180.88	184.55	188.21	191.57	195.54
50 – 99	184.55	188.21	191.87	195.54	199.20
11 – 49	188.21	191.87	195.54	199.20	202.86
1 – 10	212.65	216.32	219.98	223.64	227.30

COM Yardage: 1½ yds. - price @ GR 1
 Items Per Carton: 4

Weight: 25 lbs
 Shipping Class: 150



Smooth Back Stool

SBBS - PS**Features**

46" H x 17½" W x 20" D
 30" Seat Height
 1½" Thick Seat
 1¼" Rd. Steel Tubing (16 Gauge)
 #15 Platform Glide

Optional:

24" Seat Height (Add \$20.76)

Quantity	Grade 1	Grade 2	Grade 3	Grade 4	Grade 5
7+	240.02	243.68	247.35	251.01	254.67
1 – 6	264.46	268.13	271.79	275.45	279.11

COM Yardage: 1½ yds. - price @ GR 1
 Items Per Carton: 1

Weight: 30 lbs
 Shipping Class: 150



Upholstered Fanback Chair

UFB - PS**Features**

37" H x 17½" W x 20" D
 18" Seat Height
 1½" Thick Seat
 1¼" Rd. Steel Tubing (16 Gauge)
 #15 Platform Glide

Quantity	Grade 1	Grade 2	Grade 3	Grade 4	Grade 5
100+	223.64	227.30	230.97	234.63	238.29
50 – 99	227.30	230.97	234.63	238.29	241.96
11 – 49	230.97	234.63	238.29	241.96	245.62
1 – 10	255.41	259.07	262.74	266.40	270.06

COM Yardage: 1½ yds. - price @ GR 1
 Items Per Carton: 2

Weight: 24 lbs
 Shipping Class: 150



Upholstered Fanback Stool

UFBBS - PS**Features**

46" H x 17½" W x 20" D
 30" Seat Height
 1½" Thick Seat
 1¼" Rd. Steel Tubing (16 Gauge)
 #15 Platform Glide

Optional:

24" Seat Height (Add \$20.76)

Quantity	Grade 1	Grade 2	Grade 3	Grade 4	Grade 5
7+	262.70	266.37	270.03	273.69	277.35
1 – 6	287.14	290.81	294.47	298.13	301.80

COM Yardage: 1½ yds. - price @ GR 1
 Items Per Carton: 1

Weight: 32 lbs
 Shipping Class: 150



Upholstered Hairpin Chair

UHP - PS**Features**

37" H x 17½" W x 20" D
 18" Seat Height
 1½" Thick Seat
 1¼" Rd. Steel Tubing (16 Gauge)
 #15 Platform Glide

Quantity	Grade 1	Grade 2	Grade 3	Grade 4	Grade 5
100+	182.94	186.60	190.27	193.93	197.59
50 – 99	186.60	190.27	193.93	197.59	201.26
11 – 49	190.27	193.93	197.59	201.26	204.92
1 – 10	214.71	218.37	222.04	225.70	229.36

COM Yardage: 1⅓ yds. - price @ GR 1
 Items Per Carton: 2

Weight: 22 lbs
 Shipping Class: 150



Upholstered Hairpin Stool

UHPBS - PS**Features**

46" H x 17½" W x 20" D
 30" Seat Height
 1½" Thick Seat
 1¼" Rd. Steel Tubing (16 Gauge)
 #15 Platform Glide

Quantity	Grade 1	Grade 2	Grade 3	Grade 4	Grade 5
7+	229.46	233.12	236.79	240.45	244.11
1 – 6	253.90	257.57	261.23	264.89	268.55

COM Yardage: 1⅓ yds. - price @ GR 1
 Items Per Carton: 1

Weight: 31 lbs
 Shipping Class: 150

Optional:

24" Seat Height (Add \$20.76)



Upholstered Slatback Chair

USB - PS**Features**

37" H x 17½" W x 20" D
 18" Seat Height
 1½" Thick Seat
 1¼" Rd. Steel Tubing (16 Gauge)
 #15 Platform Glide

Quantity	Grade 1	Grade 2	Grade 3	Grade 4	Grade 5
100+	172.94	176.61	180.27	183.93	187.59
50 – 99	176.61	180.27	183.93	187.59	191.26
11 – 49	180.27	183.93	187.59	191.26	194.92
1 – 10	204.71	208.37	212.04	215.70	219.36

COM Yardage: 1⅓ yds. - price @ GR 1
 Items Per Carton: 2

Weight: 21 lbs
 Shipping Class: 150



Upholstered Slatback Stool

USBBS - PS**Features**

46" H x 17½" W x 20" D
 30" Seat Height
 1½" Thick Seat
 1¼" Rd. Steel Tubing (16 Gauge)
 #15 Platform Glide

Quantity	Grade 1	Grade 2	Grade 3	Grade 4	Grade 5
7+	224.82	228.48	232.14	235.81	239.47
1 – 6	249.26	252.92	256.59	260.25	263.91

COM Yardage: 1⅓ yds. - price @ GR 1
 Items Per Carton: 1

Weight: 31 lbs
 Shipping Class: 150

Optional:

24" Seat Height (Add \$20.76)



Backless Stool

BLBS - PS

Features

- 30" H x 16½" W x 16½" D
- 1½" Thick Seat
- 1¼" Rd. Steel Tubing (16 Gauge)
- #15 Platform Glide

Optional:

- 24" Seat Height (Add \$20.76)

Quantity	Grade 1	Grade 2	Grade 3	Grade 4	Grade 5
7+	134.32	137.98	141.65	145.31	148.97
1-6	158.76	162.43	166.09	169.75	173.42

COM Yardage: ⅔ yds. - price @ GR 1

Weight: 22 lbs

Items Per Carton: 1

Shipping Class: 150



Stacker Chair



RO - 150 SH

Features

36" H x 17" W x 19" D
18" Seat Height
2" Sewn Hood Seat
 $\frac{1}{8}$ " Sq. Steel Tubing (16 Gauge)
#1 Platform Glide

Optional

Add \$27.78 for Chrome

Quantity	Grade 1	Grade 2	Grade 3	Grade 4	Grade 5
100+	130.24	133.90	137.57	141.23	144.89
50 - 99	133.90	137.57	141.23	144.89	148.56
11 - 49	137.57	141.23	144.89	148.56	152.22
1 - 10	162.01	165.67	169.33	173.00	176.66

COM Yardage: 1 yd. - price @ GR 1

Weight: 21 lbs

Items Per Carton: 3

Shipping Class: 150



RO - 200 WF

Features

36" H x 17" W x 19" D
18" Seat Height
2" Waterfall Seat
 $\frac{1}{8}$ " Sq. Steel Tubing (16 Gauge)
#1 Platform Glide

Optional

Add \$27.78 for Chrome

Quantity	Grade 1	Grade 2	Grade 3	Grade 4	Grade 5
100+	130.24	133.90	137.57	141.23	144.89
50 - 99	133.90	137.57	141.23	144.89	148.56
11 - 49	137.57	141.23	144.89	148.56	152.22
1 - 10	162.01	165.67	169.33	173.00	176.66

COM Yardage: 1 yd. - price @ GR 1

Weight: 21 lbs

Items Per Carton: 3

Shipping Class: 150



X - 6

Features

36" H x 16 $\frac{1}{2}$ " W x 20" D
18" Seat Height
1" Pulled Seat
 $\frac{1}{8}$ " Sq. Steel Tubing (16 Gauge)
#1 Platform Glide

Optional

Add \$27.78 for Chrome (Shown Here)

Quantity	Grade 1	Grade 2	Grade 3	Grade 4	Grade 5
100+	116.34	120.00	123.66	127.33	131.00
50 - 99	120.00	123.66	127.33	131.00	134.65
11 - 49	123.66	127.33	131.00	134.65	138.31
1 - 10	148.10	151.77	155.43	159.09	162.76

COM Yardage: $\frac{3}{4}$ yd. - price @ GR 1

Weight: 20 lbs

Items Per Carton: 4

Shipping Class: 150



X - 10

Features

33" H x 16" W x 19" D
18" Seat Height
1" Pulled Seat
 $\frac{1}{8}$ " Sq. Steel Tubing (16 Gauge)
#1 Platform Glide

Optional

Add \$27.78 for Chrome (Shown Here)

Quantity	Grade 1	Grade 2	Grade 3	Grade 4	Grade 5
100+	108.58	112.24	115.91	119.57	123.23
50 - 99	112.24	115.91	119.57	123.23	126.90
11 - 49	115.91	119.57	123.23	126.90	130.56
1 - 10	140.35	144.01	147.68	151.34	155.00

COM Yardage: $\frac{2}{3}$ yd. - price @ GR 1

Weight: 19 lbs

Items Per Carton: 4

Shipping Class: 150



X - 18

Features

- 34" H x 18" W x 22" D
- 18" Seat Height
- 1" Pulled Seat
- 1³/₁₆" Sq. Steel Tubing (16 Gauge)
- #1 Platform Glide

Optional

Add \$27.78 for Chrome

Quantity	Grade 1	Grade 2	Grade 3	Grade 4	Grade 5
100+	101.94	105.60	109.26	112.93	116.59
50 – 99	105.60	109.26	112.93	116.59	120.25
11 – 49	109.26	112.93	116.59	120.25	123.92
1 – 10	133.71	137.37	141.03	144.69	148.36

COM Yardage: 3/4 yd. - price @ GR 1
Items Per Carton: 4

Weight: 21 lbs
Shipping Class: 150



X - 18 LS

Features

- 34" H x 18" W x 22" D
- 18" Seat Height
- 2" Pulled Seat
- 1³/₁₆" Sq. Steel Tubing (16 Gauge)
- #1 Platform Glide

Optional

Add \$27.78 for Chrome

Quantity	Grade 1	Grade 2	Grade 3	Grade 4	Grade 5
100+	115.80	119.46	123.12	126.79	130.45
50 – 99	119.46	123.12	126.79	130.45	134.11
11 – 49	123.12	126.79	130.45	134.11	137.78
1 – 10	147.57	151.23	154.89	158.55	162.22

COM Yardage: 3/4 yd. - price @ GR 1
Items Per Carton: 4

Weight: 21 lbs
Shipping Class: 150



X - 18 LSIB

Features

- 34" H x 18" W x 22" D
- 18" Seat Height
- 2" Pulled Seat
- 1³/₁₆" Sq. Steel Tubing (16 Gauge)
- #1 Platform Glide

Optional

Add \$27.78 for Chrome

Quantity	Grade 1	Grade 2	Grade 3	Grade 4	Grade 5
100+	135.86	139.52	143.19	146.85	150.51
50 – 99	139.52	143.19	146.85	150.51	154.18
11 – 49	143.19	146.85	150.51	154.18	157.84
1 – 10	167.63	171.29	174.96	178.62	182.28

COM Yardage: 1 yd. - price @ GR 1
Items Per Carton: 4

Weight: 21 lbs
Shipping Class: 150

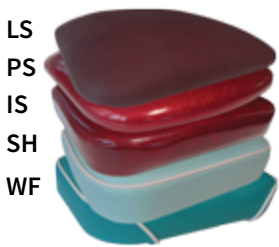

Optional Seat Pads

Extra Features For Stacker Chairs

Luxury Seat.....	add \$13.82	Diamond Back.....	add \$28.16
Sewn Hood.....	add \$17.28	Arm Rest*.....	add \$46.11
Waterfall Seat.....	add \$17.28	Stacking Bars.....	add \$18.17
Inverted Seam.....	add \$17.28	Stretcher Bar.....	add \$13.82
Channel Back.....	add \$24.17		

** Not available with all series*



X - 23

Features

- 33" H x 18" W x 22" D
- 18" Seat Height
- 1" Pulled Seat
- ¹³/₁₆" Sq. Steel Tubing (16 Gauge)
- #1 Platform Glide

Optional

Add \$27.78 for Chrome

Quantity	Grade 1	Grade 2	Grade 3	Grade 4	Grade 5
100+	78.56	82.23	85.89	89.55	93.21
50 – 99	82.23	85.89	89.55	93.21	96.88
11 – 49	85.89	89.55	93.21	96.88	100.54
1 – 10	110.33	113.99	117.66	121.32	124.98

COM Yardage: ²/₃ yd. - price @ GR 1

Weight: 21 lbs

Items Per Carton: 4

Shipping Class: 150



X - 23 AR

Features

- 33" H x 25¹/₂" W x 22" D
- 18" Seat Height
- 1" Pulled Seat
- ¹³/₁₆" Sq. Steel Tubing (16 Gauge)
- #1 Platform Glide

Optional

Add \$41.38 for Chrome

Quantity	Grade 1	Grade 2	Grade 3	Grade 4	Grade 5
100+	124.66	128.33	131.99	135.65	139.32
50 – 99	128.33	131.99	135.65	139.32	142.98
11 – 49	131.99	135.65	139.32	142.98	146.64
1 – 10	156.43	160.09	163.76	167.42	171.08

COM Yardage: ²/₃ yd. - price @ GR 1

Weight: 25 lbs

Items Per Carton: 4

Shipping Class: 150



X - 24 Econo

Features

- 33" H x 18" W x 22" D
- 18" Seat Height
- 1" Pulled Seat
- ¹³/₁₆" Sq. Steel Tubing (16 Gauge)
- #2 Economy Glide

Optional

- Available in Textured Black Only
- Upholstery Colors are Black, Cranberry, Saddle, Beige, and Dark Green

Quantity	
250+	65.75
100+	69.44
50 – 99	73.07
24 – 49	78.63

COM Yardage: N/A

Weight: 21 lbs

Items Per Carton: 4

Shipping Class: 150

* Shown with textured black frame & cranberry upholstery

ECONO

— Stack Chair —

Check Page 65 For Extra Chair Features



X - 25

Features

36" H x 18" W x 22" D
 18" Seat Height
 1" Pulled Seat
 1³/₁₆" Sq. Steel Tubing (16 Gauge)
 #2 Economy Glide

Optional

Add \$27.78 for Chrome

Quantity	Grade 1	Grade 2	Grade 3	Grade 4	Grade 5
100+	89.86	93.52	97.19	100.85	104.51
50 - 99	93.52	97.19	100.85	104.51	108.17
11 - 49	97.19	100.85	104.51	108.17	111.84
1 - 10	121.63	125.29	128.95	132.62	136.28

COM Yardage: 2/3 yd. - price @ GR 1

Weight: 22 lbs

Items Per Carton: 4

Shipping Class: 150



X - 25 WF

Features

36" H x 18" W x 22" D
 18" Seat Height
 2" Waterfall Seat
 1³/₁₆" Sq. Steel Tubing (16 Gauge)
 #2 Economy Glide

Optional

Add \$27.78 for Chrome

Quantity	Grade 1	Grade 2	Grade 3	Grade 4	Grade 5
100+	107.16	110.83	114.49	118.15	121.81
50 - 99	110.83	114.49	118.15	121.81	125.48
11 - 49	114.49	118.15	121.81	125.48	129.14
1 - 10	138.93	142.59	146.26	149.92	153.58

COM Yardage: 3/4 yd. - price @ GR 1

Weight: 22 lbs

Items Per Carton: 4

Shipping Class: 150



X - 25 ISDT

Features

36" H x 18" W x 22" D
 18" Seat Height
 2" Waterfall Seat
 1³/₁₆" Sq. Steel Tubing (16 Gauge)
 #2 Economy Glide
 Diamond Back

Optional

Add \$27.78 for Chrome

Quantity	Grade 1	Grade 2	Grade 3	Grade 4	Grade 5
100+	124.48	128.14	131.80	135.47	139.13
50 - 99	128.14	131.80	135.47	139.13	142.79
11 - 49	131.80	135.47	139.13	142.79	146.45
1 - 10	156.24	159.91	163.57	167.23	170.90

COM Yardage: 3/4 yd. - price @ GR 1

Weight: 22 lbs

Items Per Carton: 4

Shipping Class: 150



X - 25 SHCB

Features

36" H x 18" W x 22" D
 18" Seat Height
 2" Waterfall Seat
 1³/₁₆" Sq. Steel Tubing (16 Gauge)
 #2 Economy Glide
 Channel Back

Optional

Add \$27.78 for Chrome

Quantity	Grade 1	Grade 2	Grade 3	Grade 4	Grade 5
100+	124.48	128.14	131.80	135.47	139.13
50 - 99	128.14	131.80	135.47	139.13	142.79
11 - 49	131.80	135.47	139.13	142.79	146.45
1 - 10	156.24	159.91	163.57	167.23	170.90

COM Yardage: 3/4 yd. - price @ GR 1

Weight: 22 lbs

Items Per Carton: 4

Shipping Class: 150

Check Page 65 For extra chair features

*All Frames Are Painted Only

**X - 37****Features**

34" H x 18" W x 19" D
 18" Seat Height
 1" Pulled Seat
 1³/₁₆" Sq. Steel Tubing (16 gauge)
 #1 Platform Glide

Paint Only

*Powder Chrome (Shown Here)

Quantity	Grade 1	Grade 2	Grade 3	Grade 4	Grade 5
100+	115.50	119.16	122.83	126.49	130.15
50 - 99	119.16	122.83	126.49	130.15	133.82
11 - 49	122.83	126.49	130.15	133.82	137.48
1 - 10	147.27	150.93	154.59	158.26	161.92

COM Yardage: 3/4 yd. - price @ GR 1

Weight: 22 lbs

Items Per Carton: 4

Shipping Class: 150

**X - 37 LS****Features**

34" H x 18" W x 19" D
 18" Seat Height
 2" Pulled Seat
 1³/₁₆" Sq. Steel Tubing (16 Gauge)
 #1 Platform Glide

Paint Only

Quantity	Grade 1	Grade 2	Grade 3	Grade 4	Grade 5
100+	129.32	132.98	136.64	140.31	143.97
50 - 99	132.98	136.64	140.31	143.97	147.63
11 - 49	136.64	140.31	143.97	147.63	151.29
1 - 10	161.08	164.75	168.41	172.07	175.74

COM Yardage: 3/4 yd. - price @ GR 1

Weight: 22 lbs

Items Per Carton: 4

Shipping Class: 150

**X - 37 WF****Features**

34" H x 18" W x 19" D
 18" Seat Height
 2" Waterfall Seat
 1³/₁₆" Sq. Steel Tubing (16 Gauge)
 #1 Platform Glide

Paint Only

Quantity	Grade 1	Grade 2	Grade 3	Grade 4	Grade 5
100+	132.84	136.50	140.16	143.83	147.49
50 - 99	136.50	140.16	143.83	147.49	151.15
11 - 49	140.16	143.83	147.49	151.15	154.81
1 - 10	164.60	168.27	171.93	175.59	179.26

COM Yardage: 3/4 yd. - price @ GR 1

Weight: 22 lbs

Items Per Carton: 4

Shipping Class: 150

**X - 37 ISCB****Features**

34" H x 18" W x 19" D
 18" Seat Height
 2" Sewn Hood Seat
 1³/₁₆" Sq. Steel Tubing (16 Gauge)
 #1 Platform Glide

Paint Only

*Powder Chrome (Shown Here)

Quantity	Grade 1	Grade 2	Grade 3	Grade 4	Grade 5
100+	150.04	153.70	157.37	161.03	164.69
50 - 99	153.70	157.37	161.03	164.69	168.36
11 - 49	157.37	161.03	164.69	168.36	172.02
1 - 10	181.81	185.47	189.13	192.80	196.46

COM Yardage: 3/4 yd. - price @ GR 1

Weight: 22 lbs

Items Per Carton: 4

Shipping Class: 150

Check Page 65 For Extra Chair Features

**X - 38****Features**

34" H x 18" W x 19" D
 18" Seat Height
 1" Pulled Seat
 $\frac{3}{16}$ " Sq. Steel Tubing (16 Gauge)
 #1 Platform Glide

Optional

Add \$27.78 for Chrome

Quantity	Grade 1	Grade 2	Grade 3	Grade 4	Grade 5
100+	103.82	107.48	111.14	114.81	118.47
50 - 99	107.48	111.14	114.81	118.47	122.13
11 - 49	111.14	114.81	118.47	122.13	125.80
1 - 10	135.59	139.25	142.91	146.58	150.24

COM Yardage: $\frac{3}{4}$ yd. - price @ GR 1

Weight: 21 lbs

Items Per Carton: 4

Shipping Class: 150

**X - 38 LS****Features**

34" H x 18" W x 19" D
 18" Seat Height
 2" Pulled Seat
 $\frac{3}{16}$ " Sq. Steel Tubing (16 Gauge)
 #1 Platform Glide

Optional

Add \$27.78 for Chrome

Quantity	Grade 1	Grade 2	Grade 3	Grade 4	Grade 5
100+	117.66	121.32	124.98	128.65	132.31
50 - 99	121.32	124.98	128.65	132.31	135.97
11 - 49	124.98	128.65	132.31	135.97	139.63
1 - 10	149.42	153.09	156.75	160.41	164.08

COM Yardage: $\frac{3}{4}$ yd. - price @ GR 1

Weight: 21 lbs

Items Per Carton: 4

Shipping Class: 150

**X - 38 WF****Features**

34" H x 18" W x 19" D
 18" Seat Height
 2" Waterfall Seat
 $\frac{3}{16}$ " Sq. Steel Tubing (16 Gauge)
 #1 Platform Glide

Optional

Add \$27.78 for Chrome

Quantity	Grade 1	Grade 2	Grade 3	Grade 4	Grade 5
100+	121.08	124.74	128.40	132.07	135.73
50 - 99	124.74	128.40	132.07	135.73	139.39
11 - 49	128.40	132.07	135.73	139.39	143.06
1 - 10	152.85	156.51	160.17	163.83	167.50

COM Yardage: $\frac{3}{4}$ yd. - price @ GR 1

Weight: 21 lbs

Items Per Carton: 4

Shipping Class: 150

**X - 38 LSDT****Features**

34" H x 18" W x 19" D
 18" Seat Height
 2" Pulled Seat
 $\frac{3}{16}$ " Sq. Steel Tubing (16 Gauge)
 #1 Platform Glide

Diamond Tufted Back

Chrome Nails

Optional

Add \$27.78 for Chrome

Quantity	Grade 1	Grade 2	Grade 3	Grade 4	Grade 5
100+	134.88	138.55	142.21	145.87	149.53
50 - 99	138.55	142.21	145.87	149.53	153.20
11 - 49	142.21	145.87	149.53	153.20	156.86
1 - 10	166.65	170.31	173.98	177.64	181.30

COM Yardage: $\frac{3}{4}$ yd. - price @ GR 1

Weight: 21 lbs

Items Per Carton: 4

Shipping Class: 150

**All Frames Are Painted Only*



X - 43

Features

- 32" H x 18" W x 22" D
- 18" Seat Height
- 1" Pulled Seat
- 1" Sq. Steel Tubing (16 Gauge)
- #1 Platform Glide

Paint Only

Quantity	Grade 1	Grade 2	Grade 3	Grade 4	Grade 5
100+	123.32	126.98	130.65	134.31	137.97
50 - 99	126.98	130.65	134.31	137.97	141.64
11 - 49	130.65	134.31	137.97	141.64	145.30
1 - 10	155.09	158.75	162.42	166.08	169.74

COM Yardage: ¾ yd. - price @ GR 1
Items Per Carton: 4

Weight: 21 lbs
Shipping Class: 150



X - 43 WF

Features

- 32" H x 18" W x 22" D
- 18" Seat Height
- 2" Waterfall Seat
- 1" Sq. Steel Tubing (16 Gauge)
- #1 Platform Glide

Paint Only

**Requires Special Chair Caddy*

Quantity	Grade 1	Grade 2	Grade 3	Grade 4	Grade 5
100+	140.56	144.22	147.88	151.55	155.21
50 - 99	144.22	147.88	151.55	155.21	158.87
11 - 49	147.88	151.55	155.21	158.87	162.54
1 - 10	172.33	175.99	179.65	183.32	186.98

COM Yardage: ¾ yd. - price @ GR 1
Items Per Carton: 4

Weight: 21 lbs
Shipping Class: 150



X - 43 WFHR

Features

- 32" H x 18" W x 22" D
- 18" Seat Height
- 2" Waterfall Seat
- 1" Sq. Steel Tubing (16 gauge)
- #1 Platform Glide
- Head Roll

Paint Only

**Requires Special Chair Caddy*

Quantity	Grade 1	Grade 2	Grade 3	Grade 4	Grade 5
100+	157.82	161.48	165.14	168.81	172.47
50 - 99	161.48	165.14	168.81	172.47	176.13
11 - 49	165.14	168.81	172.47	176.13	179.80
1 - 10	189.59	193.25	196.91	200.57	204.24

COM Yardage: ¾ yd. - price @ GR 1
Items Per Carton: 4

Weight: 21 lbs
Shipping Class: 150

- LS
- PS
- IS
- SH
- WF



Optional Seat Pads

Extra Features For Stacker Chairs

Luxury Seat.....	add \$13.82	Diamond Back.....	add \$28.16
Sewn Hood.....	add \$17.28	Arm Rest*.....	add \$46.11
Waterfall Seat.....	add \$17.28	Stacking Bars.....	add \$18.17
Inverted Seam.....	add \$17.28	Stretcher Bar.....	add \$13.82
Channel Back.....	add \$24.17	<i>*Not available with all series</i>	

Check Page 65 For Extra Chair Features



X - 45

Features

34" H x 18" W x 19" D
18" Seat Height
1" Pulled Seat
 $\frac{1}{4}$ " Sq. Steel Tubing (16 Gauge)
#1 Platform Glide

Optional

Add \$27.78 for Chrome

Quantity	Grade 1	Grade 2	Grade 3	Grade 4	Grade 5
100+	91.08	94.74	98.41	102.07	105.73
50 - 99	94.74	98.41	102.07	105.73	109.40
11 - 49	98.41	102.07	105.73	109.40	113.06
1 - 10	122.85	126.51	130.17	133.84	137.50

COM Yardage: $\frac{2}{3}$ yd. - price @ GR 1

Weight: 22 lbs

Items Per Carton: 4

Shipping Class: 150



X - 45 LS

Features

34" H x 18" W x 19" D
18" Seat Height
2" Pulled Seat
 $\frac{1}{4}$ " Sq. Steel Tubing (16 Gauge)
#1 Platform Glide

Optional

Add \$27.78 for Chrome

Quantity	Grade 1	Grade 2	Grade 3	Grade 4	Grade 5
100+	104.62	108.28	111.95	115.61	119.27
50 - 99	108.28	111.95	115.61	119.27	122.94
11 - 49	111.95	115.61	119.27	122.94	126.60
1 - 10	136.39	140.05	143.72	147.38	151.04

COM Yardage: $\frac{3}{4}$ yd. - price @ GR 1

Weight: 22 lbs

Items Per Carton: 4

Shipping Class: 150



X - 45 SH

Features

34" H x 18" W x 19" D
18" Seat Height
2" Sewn Hood Seat
 $\frac{1}{4}$ " Sq. Steel Tubing (16 Gauge)
#1 Platform Glide

Optional

Add \$27.78 for Chrome

Quantity	Grade 1	Grade 2	Grade 3	Grade 4	Grade 5
100+	108.02	111.68	115.35	119.01	122.67
50 - 99	111.68	115.35	119.01	122.67	126.34
11 - 49	115.35	119.01	122.67	126.34	130.00
1 - 10	139.79	143.45	147.11	150.78	154.44

COM Yardage: $\frac{3}{4}$ yd. - price @ GR 1

Weight: 22 lbs

Items Per Carton: 4

Shipping Class: 150



X - 45 WFCB

Features

34" H x 18" W x 19" D
18" Seat Height
2" Waterfall Seat
 $\frac{1}{4}$ " Sq. Steel Tubing (16 Gauge)
#1 Platform Glide
Channel Back

Optional

Add \$27.78 for Chrome

Quantity	Grade 1	Grade 2	Grade 3	Grade 4	Grade 5
100+	124.94	128.60	132.26	135.93	139.59
50 - 99	128.60	132.26	135.93	139.59	143.25
11 - 49	132.26	135.93	139.59	143.25	146.92
1 - 10	156.71	160.37	164.03	167.70	171.36

COM Yardage: $\frac{3}{4}$ yd. - price @ GR 1

Weight: 22 lbs

Items Per Carton: 4

Shipping Class: 150

Faculty



907 - 242 WF

Features

29¼" H x 22½" W x 20" D
18" Seat Height
2" Waterfall Seat
#7 Platform Glide
#20 DBL Plate
Swivels 360°

Optional

Add \$27.78 for Chrome (Shown Here)

Quantity	Grade 1	Grade 2	Grade 3	Grade 4	Grade 5
100+	261.50	265.17	268.83	272.49	276.16
50 - 99	265.17	268.83	272.49	276.16	279.82
11 - 49	268.83	272.49	276.16	279.82	283.48
1 - 10	293.27	296.93	300.60	304.26	307.92

COM Yardage: 1¼ yds. - price @ GR 1

Weight: 25 lbs

Items Per Carton: 1

Shipping Class: 150



S - 3 Tilting

Features

31" H x 20½" W x 25¾" D
18" Seat Height
1" Pulled Seat
16 Gauge Frame
Chrome Frame
Paint Frame Available

Quantity	Grade 1	Grade 2	Grade 3	Grade 4	Grade 5
100+	294.47	298.13	301.80	305.46	309.12
50 - 99	298.13	301.80	305.46	309.12	312.79
11 - 49	301.80	305.46	309.12	312.79	316.45
1 - 10	326.24	329.90	333.56	337.23	340.89

COM Yardage: ¾ yd. - price @ GR 1

Weight: 26 lbs

Items Per Carton: 1

Shipping Class: 150



S - 4 Non - Tilting

Features

31" H x 20½" W x 25¾" D
18" Seat Height
1" Pulled Seat
16 Gauge Frame
Chrome Frame
Paint Frame Available

Quantity	Grade 1	Grade 2	Grade 3	Grade 4	Grade 5
100+	282.49	286.15	289.82	293.48	297.14
50 - 99	286.15	289.82	293.48	297.14	300.81
11 - 49	289.82	293.48	297.14	300.81	304.47
1 - 10	314.26	317.92	321.59	325.25	328.91

COM Yardage: ¾ yd. - price @ GR 1

Weight: 26 lbs

Items Per Carton: 1

Shipping Class: 150

Parlor



Parlor Hairpin Chair

X - 52

Features

33" H x 16" W x 19" D
18" Seat Height
1" Pulled Seat
16 Gauge Frame
#13 Platform Glide

Optional:

Add \$39.00 for Chrome

Quantity	Grade 1	Grade 2	Grade 3	Grade 4	Grade 5
100+	96.50	100.17	103.83	107.49	111.16
50 - 99	100.17	103.83	107.49	111.16	114.82
11 - 49	103.83	107.49	111.16	114.82	118.48
1 - 10	128.27	131.93	135.60	139.26	142.92

COM Yardage: 1/3 yd. - price @ GR 1

Weight: 19 lbs

Items Per Carton: 2

Shipping Class: 150



Parlor Hairpin Stool

X - 52 BS

Features

43" H x 16" W x 20 1/2" D
30" Seat Height
1" Pulled Seat
16 Gauge Frame
#13 Platform Glide

Optional:

Add \$49.33 for Chrome

Quantity	Grade 1	Grade 2	Grade 3	Grade 4	Grade 5
7+	160.86	164.53	168.19	171.85	175.52
1 - 6	185.31	188.97	192.63	196.30	199.96

COM Yardage: 2/3 yd. - price @ GR 1

Weight: 23 lbs

Items Per Carton: 1

Shipping Class: 150



Parlor Sweetheart Chair

X - 53

Features

33" H x 16" W x 19" D
18" Seat Height
1" Pulled Seat
16 Gauge Frame
#13 Platform Glide

Optional:

Add \$39.00 for Chrome

Quantity	Grade 1	Grade 2	Grade 3	Grade 4	Grade 5
100+	108.04	111.71	115.37	119.03	122.69
50 - 99	111.71	115.37	119.03	122.69	126.36
11 - 49	115.37	119.03	122.69	126.36	130.02
1 - 10	139.81	143.47	147.14	150.80	154.46

COM Yardage: 1/3 yd. - price @ GR 1

Weight: 19 lbs

Items Per Carton: 2

Shipping Class: 150



Parlor Sweetheart Stool

X - 53 BS

Features

43" H x 16" W x 20 1/2" D
30" Seat Height
1" Pulled Seat
16 Gauge Frame
#13 Platform Glide

Optional:

Add \$49.33 for Chrome

Quantity	Grade 1	Grade 2	Grade 3	Grade 4	Grade 5
7+	169.28	172.94	176.61	180.27	183.93
1 - 6	193.72	197.38	201.05	204.71	208.37

COM Yardage: 1/3 yd. - price @ GR 1

Weight: 23 lbs

Items Per Carton: 1

Shipping Class: 150

All Frames Are 16 Steel Gauge

Parlor Upholstered
Hairpin Chair**X - 54****Features**

33" H x 16" W x 19½" D
18" Seat Height
1" Pulled Seat
16 Gauge Frame
#13 Platform Glide

Optional:

Add \$39.00 for Chrome

Quantity	Grade 1	Grade 2	Grade 3	Grade 4	Grade 5
100+	116.04	119.70	123.37	127.03	130.69
50 - 99	119.70	123.37	127.03	130.69	134.35
11 - 49	123.37	127.03	130.69	134.35	138.02
1 - 10	147.81	151.47	155.13	158.80	162.46

COM Yardage: ½ yd. - price @ GR 1
Items Per Carton: 2

Weight: 22 lbs
Shipping Class: 150

Parlor Upholstered
Hairpin Stool**X - 54 BS****Features**

43" H x 16" W x 20½" D
30" Seat Height
1" Pulled Seat
16 Gauge Frame
#13 Platform Glide

Optional:

Add \$49.33 for Chrome

Quantity	Grade 1	Grade 2	Grade 3	Grade 4	Grade 5
7+	203.86	207.53	211.19	214.85	218.52
1 - 6	228.31	231.97	235.63	239.29	242.96

COM Yardage: ½ yd. - price @ GR 1
Items Per Carton: 1

Weight: 25 lbs
Shipping Class: 150

Parlor Fanback Chair
(5 Spindle)**X - 55****Features**

33" H x 16" W x 19½" D
18" Seat Height
1" Pulled Seat
16 Gauge Frame
#13 Platform Glide

Optional:

Four Spindle (X-56)
Add \$39.00 for Chrome

Quantity	Grade 1	Grade 2	Grade 3	Grade 4	Grade 5
100+	101.60	105.26	108.92	112.59	116.25
50 - 99	105.26	108.92	112.59	116.25	119.91
11 - 49	108.92	112.59	116.25	119.91	123.57
1 - 10	133.36	137.03	140.69	144.35	148.02

COM Yardage: ½ yd. - price @ GR 1
Items Per Carton: 2

Weight: 19 lbs
Shipping Class: 150



Parlor Fanback Stool

X - 55 BS**Features**

43" H x 16" W x 20½" D
30" Seat Height
1" Pulled Seat
16 Gauge Frame
#13 Platform Glide

Optional:

Add \$49.33 for Chrome

Quantity	Grade 1	Grade 2	Grade 3	Grade 4	Grade 5
7+	166.72	170.38	174.04	177.71	181.37
1 - 6	191.16	194.82	198.48	202.15	205.81

COM Yardage: ½ yd. - price @ GR 1
Items Per Carton: 1

Weight: 21 lbs
Shipping Class: 150

Classic Chairs & Stools



Curved Back

921

Features

31½" H x 15¼" W x 22½" D
18" Seat Height
1" Pulled Seat
1" Rd. Tubing (16 Gauge)
#6 Platform Glide

Optional:

Add \$17.28 for Sewn Hood Seat

Quantity	Grade 1	Grade 2	Grade 3	Grade 4	Grade 5
100+	110.80	114.46	118.12	121.79	125.45
50 – 99	114.46	118.12	121.79	125.45	129.11
11 – 49	118.12	121.79	125.45	129.11	132.77
1 – 10	142.56	146.23	149.89	153.55	157.22

COM Yardage: ¾ yd. - price @ GR 1

Weight: 20 lbs

Items Per Carton: 2

Shipping Class: 150



Curved "V" Back

921 "V"

Features

31½" H x 15¼" W x 22½" D
18" Seat Height
1" Pulled Seat
1" Rd. Tubing (16 Gauge)
#6 Platform Glide

Optional:

Add \$17.28 for Sewn Hood Seat

Quantity	Grade 1	Grade 2	Grade 3	Grade 4	Grade 5
100+	123.40	127.07	130.73	134.39	138.05
50 – 99	127.07	130.73	134.39	138.05	141.72
11 – 49	130.73	134.39	138.05	141.72	145.38
1 – 10	155.17	158.83	162.50	166.16	169.82

COM Yardage: ¾ yd. - price @ GR 1

Weight: 20 lbs

Items Per Carton: 2

Shipping Class: 150



Curved Diamond Tuft Back

921 DT

Features

31½" H x 15¼" W x 22½" D
18" Seat Height
1" Pulled Seat
1" Rd. Tubing (16 Gauge)
#6 Platform Glide

Optional:

Add \$17.28 for Sewn Hood Seat

Quantity	Grade 1	Grade 2	Grade 3	Grade 4	Grade 5
100+	138.98	142.64	146.30	149.97	153.63
50 – 99	142.64	146.30	149.97	153.63	157.29
11 – 49	146.30	149.97	153.63	157.29	160.96
1 – 10	170.75	174.41	178.07	181.74	185.40

COM Yardage: ¾ yd. - price @ GR 1

Weight: 20 lbs

Items Per Carton: 2

Shipping Class: 150



Curved Back Stool

921 BS

Features

43½" H x 15¼" W x 22½" D
30" Seat Height
1" Pulled Seat
1" Rd. Tubing (16 Gauge)
#6 Platform Glide

Optional:

Add \$17.28 for Sewn Hood Seat

Add \$24.17 for "V"

Quantity	Grade 1	Grade 2	Grade 3	Grade 4	Grade 5
7+	185.66	189.32	192.98	196.65	200.31
1 – 6	210.10	213.76	217.43	221.09	224.75

COM Yardage: ¾ yd. - price @ GR 1

Weight: 25 lbs

Items Per Carton: 1

Shipping Class: 150



Elite Style Back

921 ELSH

Features

- 31½" H x 15¼" W x 22½" D
- 18" Seat Height
- 2" Sewn Hood Seat
- 1" Rd. Steel Tubing (16 Gauge)
- #6 Platform Glide

Quantity	Grade 1	Grade 2	Grade 3	Grade 4	Grade 5
100+	163.20	166.86	170.53	174.19	177.85
50 – 99	166.86	170.53	174.19	177.85	181.52
11 – 49	170.53	174.19	177.85	181.52	185.18
1 – 10	194.97	198.63	202.29	205.96	209.62

COM Yardage: ¾ yd. - price @ GR 1
Items Per Carton: 2

Weight: 20lbs
Shipping Class: 150



Elite Style Stool

921 ELSH - BS

Features

- 43½" H x 15¼" W x 22½" D
- 30" Seat Height
- 2" Sewn Hood Seat
- 1" Rd. Steel Tubing (16 Gauge)
- #6 Platform Glide

Quantity	Grade 1	Grade 2	Grade 3	Grade 4	Grade 5
7+	252.92	256.59	260.25	263.91	267.57
1 – 6	277.36	281.03	284.69	288.35	292.02

COM Yardage: ¾ yd. - price @ GR 1
Items Per Carton: 1

Weight: 25lbs
Shipping Class: 150



Malibu Style Back

921 MBWF

Features

- 31½" H x 15¼" W x 22½" D
- 18" Seat Height
- 2" Waterfall Seat
- 1" Rd. Steel Tubing (16 Gauge)
- #6 Platform Glide

Quantity	Grade 1	Grade 2	Grade 3	Grade 4	Grade 5
100+	163.20	166.86	170.53	174.19	177.85
50 – 99	166.86	170.53	174.19	177.85	181.52
11 – 49	170.53	174.19	177.85	181.52	185.18
1 – 10	194.97	198.63	202.29	205.96	209.62

COM Yardage: ¾ yd. - price @ GR 1
Items Per Carton: 2

Weight: 20lbs
Shipping Class: 150



Malibu Style Stool

921 MBWF - BS

Features

- 43½" H x 15¼" W x 22½" D
- 30" Seat Height
- 2" Waterfall Seat
- 1" Rd. Steel Tubing (16 Gauge)
- #6 Platform Glide

Quantity	Grade 1	Grade 2	Grade 3	Grade 4	Grade 5
7+	252.92	256.59	260.25	263.91	267.57
1 – 6	277.36	281.03	284.69	288.35	292.02

COM Yardage: ¾ yd. - price @ GR 1
Items Per Carton: 1

Weight: 25lbs
Shipping Class: 150



*Curved Back with
Chrome Handle*

921 HB

Features

31½" H x 15¼" W x 22½" D
18" Seat Height
1" Pulled Seat
1" Rd. Tubing (16 Gauge)
#6 Platform Glide

Optional:

Add \$17.28 for Sewn Hood Seat

Quantity	Grade 1	Grade 2	Grade 3	Grade 4	Grade 5
100+	167.58	171.24	174.90	178.57	182.23
50 – 99	171.24	174.90	178.57	182.23	185.89
11 – 49	174.90	178.57	182.23	185.89	189.56
1 – 10	199.35	203.01	206.67	210.34	214.00

COM Yardage: ¾ yd. - price @ GR 1

Weight: 17 lbs

Items Per Carton: 2

Shipping Class: 150



*Curved Back Stool
with Chrome Handle*

921 HB - BS

Features

43½" H x 15¼" W x 22½" D
30" Seat Height
1" Pulled Seat
1" Rd. Tubing (16 Gauge)
#6 Platform Glide

Optional:

Add \$17.28 for Sewn Hood Seat

Quantity	Grade 1	Grade 2	Grade 3	Grade 4	Grade 5
7+	257.38	261.04	264.70	268.37	272.03
1 – 6	281.82	285.48	289.15	292.81	296.47

COM Yardage: ¾ yd. - price @ GR 1

Weight: 25 lbs

Items Per Carton: 1

Shipping Class: 150



*Curved Back with
Chrome Handle*

921 HBSH

Features

31½" H x 15¼" W x 22½" D
18" Seat Height
2" Sewn Hood Seat
1" Rd. Tubing (16 Gauge)
#6 Platform Glide

Optional:

Accent Piping (Shown Here)

Quantity	Grade 1	Grade 2	Grade 3	Grade 4	Grade 5
100+	184.88	188.54	192.21	195.87	199.53
50 – 99	188.54	192.21	195.87	199.53	203.20
11 – 49	192.21	195.87	199.53	203.20	206.86
1 – 10	216.65	220.31	223.98	227.64	231.30

COM Yardage: ¾ yd. - price @ GR 1

Weight: 17 lbs

Items Per Carton: 2

Shipping Class: 150



*Curved Back Stool
with Chrome Handle*

921 HBWF - BS

Features

43½" H x 15¼" W x 22½" D
30" Seat Height
2" Waterfall Seat
1" Rd. Tubing (16 Gauge)
#6 Platform Glide

Optional:

Accent Piping (Shown Here)

Quantity	Grade 1	Grade 2	Grade 3	Grade 4	Grade 5
7+	274.64	278.30	281.96	285.63	289.29
1 – 6	299.08	302.74	306.40	310.07	313.73

COM Yardage: ¾ yd. - price @ GR 1

Weight: 25 lbs

Items Per Carton: 1

Shipping Class: 150



Malibu Style Handle Back

921 HBMBSH

Features

- 31½" H x 15¼" W x 22½" D
- 18" Seat Height
- 2" Sewn Hood Seat
- 1" Rd. Steel Tubing (16 Gauge)
- #6 Platform Glide

Quantity	Grade 1	Grade 2	Grade 3	Grade 4	Grade 5
100+	209.08	212.74	216.41	220.07	223.73
50 – 99	212.74	216.41	220.07	223.73	227.40
11 – 49	216.41	220.07	223.73	227.40	231.06
1 – 10	240.85	244.51	248.18	251.84	255.50

COM Yardage: ¾ yd. - price @ GR 1 Weight: 17lbs
 Items Per Carton: 2 Shipping Class: 150



Malibu Style Handle Back Stool

921 HBMBWF - BS

Features

- 43½" H x 15¼" W x 22½" D
- 30" Seat Height
- 2" Waterfall Seat
- 1" Rd. Steel Tubing (16 Gauge)
- #6 Platform Glide

Quantity	Grade 1	Grade 2	Grade 3	Grade 4	Grade 5
7+	298.80	302.47	306.13	309.79	313.46
1 – 6	323.25	326.91	330.57	334.23	337.90

COM Yardage: ¾ yd. - price @ GR 1 Weight: 25lbs
 Items Per Carton: 1 Shipping Class: 150



Classic Button Back

921 BB

Features

- 32" H x 15¼" W x 22½" D
- 18" Seat Height
- 1" Pulled Seat
- 1" Rd. Tubing (16 Gauge)
- #6 Platform Glide

Quantity	Grade 1	Grade 2	Grade 3	Grade 4	Grade 5
100+	123.40	127.07	130.73	134.39	138.05
50 – 99	127.07	130.73	134.39	138.05	141.72
11 – 49	130.73	134.39	138.05	141.72	145.38
1 – 10	155.17	158.83	162.50	166.16	169.82

Optional:

Add \$17.28 for Sewn Hood Seat

COM Yardage: ¾ yd. - price @ GR 1 Weight: 17lbs
 Items Per Carton: 2 Shipping Class: 150



Small Curved Back

934

Features

- 32" H x 17" W x 22½" D
- 18" Seat Height
- 1" Pulled Seat
- 1" Rd. Tubing (16 Gauge)
- #6 Platform Glide

Quantity	Grade 1	Grade 2	Grade 3	Grade 4	Grade 5
100+	138.27	141.93	145.59	149.26	152.92
50 – 99	141.93	145.59	149.26	152.92	156.58
11 – 49	145.59	149.26	152.92	156.58	160.24
1 – 10	170.03	173.70	177.36	181.02	184.69

Optional:

Add \$17.28 for Sewn Hood Seat

COM Yardage: ½ yd. - price @ GR 1 Weight: 15lbs
 Items Per Carton: 2 Shipping Class: 150



Classic Channel Back

939 CBWF

Features

- 32" H x 15¼" W x 22½" D
- 18" Seat Height
- 2" Waterfall Seat
- 1" Rd. Tubing (16 Gauge)
- #6 Platform Glide

Optional:

Add \$24.17 for 3 Middle Channels in Different Colored Upholstery

Quantity	Grade 1	Grade 2	Grade 3	Grade 4	Grade 5
100+	163.20	166.86	170.53	174.19	177.85
50 – 99	166.86	170.53	174.19	177.85	181.52
11 – 49	170.53	174.19	177.85	181.52	185.18
1 – 10	194.97	198.63	202.29	205.96	209.62

COM Yardage: 1⅓ yds. - price @ GR 1
 Items Per Carton: 2

Weight: 20 lbs
 Shipping Class: 150



Classic Stools



215 - 46

Features

30" H x 15" W x 15" D
 Revolving Seat
 1" Pulled Seat
 1" Rd. Steel Tubing (16 Gauge)
 #11 Acrylic Glide
 #18 Swivel

Chrome Only

Quantity	Grade 1	Grade 2	Grade 3	Grade 4	Grade 5
7+	140.88	144.81	148.84	153.01	157.30
1-6	165.32	169.25	173.28	177.45	181.74

COM Yardage: 1/3 yd. - price @ GR 1

Weight: 25 lbs

Items Per Carton: 1

Shipping Class: 150

Seat Diameter: 14"



215 - 125 R

Features

30" H x 15" W x 15" D
 Revolving Seat
 1" Pulled Seat
 1" Rd. Steel Tubing (16 Gauge)
 #11 Acrylic Glide
 #18 Swivel

Chrome Only

Quantity	Grade 1	Grade 2	Grade 3	Grade 4	Grade 5
7+	130.78	134.71	138.74	142.90	147.19
1-6	155.22	159.15	163.19	167.34	171.63

COM Yardage: 2/3 yd. - price @ GR 1

Weight: 25 lbs

Items Per Carton: 1

Shipping Class: 150

Seat Diameter: 14"



215 - 125 RB

Features

30" H x 15" W x 15" D
 Revolving Seat
 1" Pulled Seat
 1" Rd. Steel Tubing (16 Gauge)
 #11 Acrylic Glide
 #18 Swivel

Chrome Only

Quantity	Grade 1	Grade 2	Grade 3	Grade 4	Grade 5
7+	213.73	219.91	226.28	232.84	239.59
1-6	238.17	244.36	250.72	257.28	264.03

COM Yardage: 7/8 yd. - price @ GR 1

Weight: 30 lbs

Items Per Carton: 1

Shipping Class: 150

Seat Diameter: 14"



215 - 530

Features

30" H x 15" W x 15" D
 Revolving Seat
 1" Pulled Seat
 1" Rd. Steel Tubing (16 Gauge)
 #11 Acrylic Glide
 #20 DBL Plate Swivel

Chrome Only

Quantity	Grade 1	Grade 2	Grade 3	Grade 4	Grade 5
7+	182.29	187.54	192.93	198.49	204.22
1-6	206.74	211.98	217.37	222.93	228.66

COM Yardage: 3/4 yd. - price @ GR 1

Weight: 30 lbs

Items Per Carton: 1

Shipping Class: 150

Seat Width: 15"

Standard Chrome Finish & Revolving Seats



215 - 531 SH

Features

30" H x 15" W x 15" D
 Revolving Seat
 2" Sewn Seat
 1" Rd. Steel Tubing (16 Gauge)
 #11 Acrylic Glide
 #20 DBL Plate Swivel

Quantity	Grade 1	Grade 2	Grade 3	Grade 4	Grade 5
7+	187.03	192.42	197.96	203.67	209.55
1-6	211.48	216.87	224.40	228.11	233.99

COM Yardage: ¾ yd. - price @ GR 1

Weight: 27 lbs

Items Per Carton: 1

Shipping Class: 150

Seat Width: 15"



215 - 782/49 NS

Features

30" H x 15" W x 15" D
 Revolving Seat
 Black & Red Stripe at No Cost
 #18 Swivel

Optional:

Custom Color Stripes (See pg.93)

Quantity	Grade 1	Grade 2	Grade 3	Grade 4	Grade 5
7+	135.72	139.49	143.38	147.38	151.49
1-6	160.16	163.93	167.82	171.82	175.94

COM Yardage: ½ yd. - price @ GR 1

Weight: 25 lbs

Items Per Carton: 1

Shipping Class: 150

Seat Diameter: 14"



215 - 782 RB/49 NSRB

Features

30" H x 15" W x 15" D
 Revolving Seat
 Black & Red Stripe at No Cost
 #18 Swivel

Optional:

Custom Color Stripes (See pg.93)

Quantity	Grade 1	Grade 2	Grade 3	Grade 4	Grade 5
7+	208.08	213.79	219.68	225.74	231.98
1-6	232.52	238.23	244.12	250.18	256.43

COM Yardage: ¾ yd. - price @ GR 1

Weight: 30 lbs

Items Per Carton: 1

Shipping Class: 150

Seat Diameter: 14"



215 - 921

Features

30" H x 15" W x 15" D
 Revolving Seat
 1" Pulled Seat
 1" Rd. Steel Tubing (16 Gauge)
 #11 Acrylic Glide
 #20 DBL Plate Swivel

Quantity	Grade 1	Grade 2	Grade 3	Grade 4	Grade 5
7+	182.29	187.54	192.93	198.49	204.22
1-6	206.74	211.98	217.37	222.93	228.66

COM Yardage: ¾ yd. - price @ GR 1

Weight: 30 lbs

Items Per Carton: 1

Shipping Class: 150

Seat Width: 15"

Chrome Finish Only & Revolving Seats



Scalloped Ring Stool

250 - 49 NS

Features

30" H x 16" W x 16" D
 Revolving Seat
 1" Pulled Seat
 1¼" Rd. Steel Tubing (16 Gauge)
 #15 Glide
 #18 Swivel

Quantity	Grade 1	Grade 2	Grade 3	Grade 4	Grade 5
7+	265.27	272.02	278.97	286.13	293.52
1 - 6	289.71	296.46	303.42	310.58	317.96

COM Yardage: ⅓ yd. - price @ GR 1 Weight: 25 lbs
 Items Per Carton: 1 Shipping Class: 150
 Seat Diameter: 14"



Scalloped Ring Stool with Back

250 - 49 NSRB

Features

30" H x 16" W x 16" D
 Revolving Seat
 1" Pulled Seat
 1¼" Rd. Steel Tubing (16 Gauge)
 #15 Glide
 #18 Swivel

Quantity	Grade 1	Grade 2	Grade 3	Grade 4	Grade 5
7+	332.38	340.92	349.72	358.77	368.10
1 - 6	356.82	365.36	374.16	383.21	392.54

COM Yardage: ⅔ yd. - price @ GR 1 Weight: 30 lbs
 Items Per Carton: 1 Shipping Class: 150
 Seat Diameter: 14"



Bulged Ring Stool

250 - 781/46

Features

30" H x 16" W x 16" D
 Revolving Seat
 1" Pulled Seat
 1¼" Rd. Steel Tubing (16 Gauge)
 #15 Glide
 #18 Swivel

Quantity	Grade 1	Grade 2	Grade 3	Grade 4	Grade 5
7+	242.51	248.58	254.83	261.27	267.91
1 - 6	266.95	273.02	279.27	285.72	292.35

COM Yardage: ⅓ yd. - price @ GR 1 Weight: 21 lbs
 Items Per Carton: 1 Shipping Class: 150
 Seat Diameter: 13"



Grooved Ring Stool

250 - 782

Features

30" H x 16" W x 16" D
 Revolving Seat
 1¼" Rd. Steel Tubing (16 Gauge)
 Black & Red Stripe at No Cost
 #18 Swivel

Optional:

Custom Color Stripes (See pg.93)

Quantity	Grade 1	Grade 2	Grade 3	Grade 4	Grade 5
7+	265.27	272.02	278.97	286.13	293.52
1 - 6	289.71	296.46	303.42	310.58	317.96

COM Yardage: ⅓ yd. - price @ GR 1 Weight: 25 lbs
 Items Per Carton: 1 Shipping Class: 150
 Seat Diameter: 14"

Chrome Finish Only & Revolving Seats



**Grooved Ring
Stool with Back**

250 - 782 RB

Features

30" H x 16" W x 16" D
Revolving Seat
1¼" Rd. Steel Tubing (16 Gauge)
#15 Glide
Black & Red Stripe at No Cost
#18 Swivel

Optional:

Custom Color Stripes (See pg.93)

Quantity	Grade 1	Grade 2	Grade 3	Grade 4	Grade 5
7+	332.38	340.92	349.72	358.77	368.10
1 - 6	356.82	365.36	374.16	383.21	392.54

COM Yardage: ¾ yd. - price @ GR 1

Weight: 30 lbs

Items Per Carton: 1

Shipping Class: 150

Seat Diameter: 14"



Button Back Stool

250 - 921 BB

Features

30" H x 16" W x 16" D
Revolving Seat
1" Pulled Seat
1¼" Rd. Steel Tubing (16 Gauge)
#15 Glide
#20 DBL Plate Swivel

Optional:

2" Waterfall or Sewn Hood Seat (Add \$17.28)

Quantity	Grade 1	Grade 2	Grade 3	Grade 4	Grade 5
7+	312.14	320.37	328.85	337.58	346.57
1 - 6	336.58	344.81	353.29	362.03	371.01

COM Yardage: ¾ yd. - price @ GR 1

Weight: 29 lbs

Items Per Carton: 1

Shipping Class: 150

Seat Width: 15"



**Malibu Channel
Back Stool**

250 - 921 MB

Features

30" H x 16" W x 16" D
Revolving Seat
1" Pulled Seat
1¼" Rd. Steel Tubing (16 Gauge)
#15 Glide
#20 DBL Plate Swivel

Optional:

2" Waterfall or Sewn Hood Seat (Add \$17.28)

Quantity	Grade 1	Grade 2	Grade 3	Grade 4	Grade 5
7+	312.14	320.37	328.85	337.58	346.57
1 - 6	336.58	344.81	353.29	362.03	371.01

COM Yardage: ¾ yd. - price @ GR 1

Weight: 29 lbs

Items Per Carton: 1

Shipping Class: 150

Seat Width: 15"



**Curved "V"
Back Stool**

250 - 921 "V"

Features

30" H x 16" W x 16" D
Revolving Seat
1" Pulled Seat
1¼" Rd. Steel Tubing (16 Gauge)
#15 Glide
#20 DBL Plate Swivel

Optional:

2" Waterfall or Sewn Hood Seat (Add \$17.28)

Quantity	Grade 1	Grade 2	Grade 3	Grade 4	Grade 5
7+	312.14	320.37	328.85	337.58	346.57
1 - 6	336.58	344.81	353.29	362.03	371.01

COM Yardage: ¾ yd. - price @ GR 1

Weight: 29 lbs

Items Per Carton: 1

Shipping Class: 150

Seat Width: 15"

Standard Chrome Finish & Revolving Seats



**Scalloped Ring Stool
with Back**

264 - 49 NSRB

Features

30" H x 16" W x 16" D
1" Rd. Steel Tubing (16 Gauge)
#11 Acrylic Glide
#19 with Cup Swivel

Optional:

Add \$17.15 for Paint
24" Seat Height at No Cost

Quantity	Grade 1	Grade 2	Grade 3	Grade 4	Grade 5
7+	239.00	245.65	252.49	259.53	266.79
1 - 6	263.44	270.09	276.93	283.97	291.23

COM Yardage: $\frac{2}{3}$ yd. - price @ GR 1

Weight: 30lbs

Items Per Carton: 1

Shipping Class: 150

Seat Diameter: 14"



**Single Ring
Stool**

264 - 125

Features

30" H x 16" W x 16" D
1" Pulled Seat
1" Rd. Steel Tubing (16 Gauge)
#11 Acrylic Glide
#801 Swivel

Optional:

Add \$17.15 for Paint
24" Seat Height at No Cost

Quantity	Grade 1	Grade 2	Grade 3	Grade 4	Grade 5
7+	168.40	173.25	178.24	183.37	188.67
1 - 6	192.85	197.70	202.70	207.82	213.11

COM Yardage: $\frac{2}{3}$ yd. - price @ GR 1

Weight: 21lbs

Items Per Carton: 1

Shipping Class: 150

Seat Diameter: 14"



**Single Ring
Drum Stool**

264 - 161

Features

30" H x 16" W x 16" D
1" Pulled Seat
1" Rd. Steel Tubing (16 Gauge)
#11 Acrylic Glide
#801 Swivel

Optional:

Add \$17.15 for Paint
24" Seat Height at No Cost

Quantity	Grade 1	Grade 2	Grade 3	Grade 4	Grade 5
7+	186.50	191.88	197.43	203.14	209.03
1 - 6	210.94	216.32	221.87	227.58	233.47

COM Yardage: $\frac{7}{8}$ yd. - price @ GR 1

Weight: 22lbs

Items Per Carton: 1

Shipping Class: 150

Seat Diameter: 14"



**Single Ring Stool
with Back**

264 - 530

Features

30" H x 16" W x 16" D
1" Pulled Seat
1" Rd. Steel Tubing (16 Gauge)
#11 Acrylic Glide
#21 with Cup Swivel

Optional:

Add \$17.15 for Paint
24" Seat Height at No Cost

Quantity	Grade 1	Grade 2	Grade 3	Grade 4	Grade 5
7+	216.17	222.43	228.88	235.51	242.34
1 - 6	240.62	246.87	253.32	259.95	266.78

COM Yardage: $\frac{2}{3}$ yd. - price @ GR 1

Weight: 29lbs

Items Per Carton: 1

Shipping Class: 150

Seat Width: 15"

Standard Chrome Finish & Revolving Seats



Bulged Single Ring Stool

264 - 781/46

Features

30" H x 16" W x 16" D
1" Pulled Seat
1" Rd. Steel Tubing (16 Gauge)
#11 Acrylic Glide
#801 Swivel

Optional:

Add \$17.15 for Paint
24" Seat Height at No Cost

Quantity	Grade 1	Grade 2	Grade 3	Grade 4	Grade 5
7+	165.34	170.01	174.80	179.75	184.85
1 - 6	189.78	194.45	199.24	204.19	209.29

COM Yardage: 1/3 yd. - price @ GR 1

Weight: 21 lbs

Items Per Carton: 1

Shipping Class: 150

Seat Diameter: 13"



Grooved Ring Stool

264 - 782/49 NS

Features

30" H x 16" W x 16" D
Black & Red Stripe at No Cost
#801 Swivel

Optional:

Custom Color Stripes (See pg.93)
Add \$17.15 for Paint
24" Seat Height at No Cost

Quantity	Grade 1	Grade 2	Grade 3	Grade 4	Grade 5
7+	167.20	171.92	176.77	181.78	186.94
1 - 6	191.64	196.36	201.21	206.22	211.38

COM Yardage: 1/3 yd. - price @ GR 1

Weight: 22 lbs

Items Per Carton: 1

Shipping Class: 150

Seat Diameter: 14"



Grooved Ring Stool with Back

264 - 782 RB

Features

30" H x 16" W x 16" D
Black & Red Stripe at No Cost
#19 with Cup Swivel

Optional:

Custom Color Stripes (See pg.93)
Add \$17.15 for Paint
24" Seat Height at No Cost

Quantity	Grade 1	Grade 2	Grade 3	Grade 4	Grade 5
7+	239.00	245.65	252.49	259.53	266.79
1 - 6	263.44	270.09	276.93	283.97	291.23

COM Yardage: 2/3 yd. - price @ GR 1

Weight: 30 lbs

Items Per Carton: 1

Shipping Class: 150

Seat Diameter: 14"



Single Ring Stool with Back

264 - 921

Features

30" H x 16" W x 16" D
1" Pulled Seat
1" Rd. Steel Tubing (16 Gauge)
#11 Acrylic Glide
#21 with Cup Swivel

Optional:

Add \$17.15 for Paint
24" Seat Height at No Cost

Quantity	Grade 1	Grade 2	Grade 3	Grade 4	Grade 5
7+	216.17	222.43	228.88	235.51	242.34
1 - 6	240.62	246.87	253.32	259.95	266.78

COM Yardage: 2/3 yd. - price @ GR 1

Weight: 29 lbs

Items Per Carton: 1

Shipping Class: 150

Seat Width: 15"

Standard Chrome Footring



Tapered Leg Stool

265 - 125 R

Features

30" H x 16" W x 16" D
#3 Platform glide
#18 Swivel

Optional:

Add \$27.78 for Chrome (Shown Here)

Quantity	Grade 1	Grade 2	Grade 3	Grade 4	Grade 5
7+	136.22	140.32	144.53	148.86	153.33
1 - 6	160.67	164.76	168.97	173.31	177.77

COM Yardage: $\frac{2}{3}$ yd. - price @ GR 1

Weight: 22 lbs

Items Per Carton: 1

Shipping Class: 150

Seat Diameter: 14"



*Tapered Leg Stool
with Back*

265 - 125 RB

Features

30" H x 16" W x 16" D
#3 Platform Glide
#18 Swivel

Optional:

Add \$35.87 for Chrome (Shown Here)

Quantity	Grade 1	Grade 2	Grade 3	Grade 4	Grade 5
7+	202.62	208.70	214.96	221.41	228.05
1 - 6	227.06	233.15	239.40	245.85	252.49

COM Yardage: $\frac{7}{8}$ yd. - price @ GR 1

Weight: 27 lbs

Items Per Carton: 1

Shipping Class: 150

Seat Diameter: 14"



*Tapered Leg Stool
Non Revolving Seat*

265 - 214

Features

30" H x 16" W x 16" D
#3 Platform Glide
Non - Revolving

Optional:

Add \$27.78 for Chrome

Quantity	Grade 1	Grade 2	Grade 3	Grade 4	Grade 5
7+	137.08	141.20	145.43	149.80	154.29
1 - 6	161.52	165.64	169.87	174.24	178.73

COM Yardage: $\frac{1}{2}$ yd. - price @ GR 1

Weight: 21 lbs

Items Per Carton: 1

Shipping Class: 150

Seat Width: 14"



*Tapered Leg Stool
Fully Upholstered*

265 - 242 WF

Features

30" H x 16" W x 16" D
2" Waterfall Seat
#3 Platform Glide
#20 DBL Plate Swivel

Optional:

Add \$27.78 for Chrome

Quantity	Grade 1	Grade 2	Grade 3	Grade 4	Grade 5
7+	213.52	219.92	226.52	233.32	240.32
1 - 6	237.96	244.37	250.97	257.76	264.76

COM Yardage: $1\frac{1}{4}$ yds. - price @ GR 1

Weight: 27 lbs

Items Per Carton: 1

Shipping Class: 150

Seat Width: 16"

Frames Are Standard Satin Black



*Tapered Leg Stool
with Inset Back*

265 - X18 SHIB

Features

30" H x 16" W x 16" D
2" Sewn Hood Seat
#3 Platform Glide
#20 DBL Plate Swivel

Optional:

Add \$40.00 for Chrome

Quantity	Grade 1	Grade 2	Grade 3	Grade 4	Grade 5
7+	230.80	237.73	244.86	252.21	259.78
1-6	255.24	262.17	269.30	276.65	284.22

COM Yardage: $\frac{3}{4}$ yd. - price @ GR 1

Weight: 30 lbs

Items Per Carton: 1

Shipping Class: 150

Seat Width: 14"



*Tapered Leg Stool
with Straight Back*

265 - X23

Features

30" H x 16" W x 16" D
#3 Platform Glide
#20 DBL Plate Swivel

Optional:

Add \$40.00 for Chrome

Quantity	Grade 1	Grade 2	Grade 3	Grade 4	Grade 5
7+	131.90	135.86	139.93	144.13	148.46
1-6	156.34	160.30	164.37	168.58	172.90

COM Yardage: $\frac{2}{3}$ yd. - price @ GR 1

Weight: 28 lb

Items Per Carton: 1

Shipping Class: 150

Seat Width: 14"

To place your order

Ph: (478) 320-2502

Email: Jack@NewRetroDining.com



Standard Chrome Finish & Revolving Seats



Arch Leg Stool with Scalloped Seat Ring

300 - 49 NS/782

Features

30" H x 16" W x 16" D
 3½" Column
 1" Rd. Steel Tubing (16 Gauge)
 #6 Glide
 #801 Swivel

Optional:

24" Seat Height at No Cost

Quantity	Grade 1	Grade 2	Grade 3	Grade 4	Grade 5
7+	239.97	246.46	253.15	260.03	267.14
1 - 6	264.41	270.90	277.59	284.47	291.58

COM Yardage: ⅓ yd. - price @ GR 1

Weight: 22 lbs

Items Per Carton: 1

Shipping Class: 150

Seat Diameter: 14"



Arch Leg Stool with Scalloped Seat Ring with Back

300 - 49 NSRB/782 RB

Features

30" H x 16" W x 16" D
 3½" Column
 1" Rd. Steel Tubing (16 Gauge)
 #6 Glide
 #19 with Cup Swivel

Optional:

24" Seat Height at No Cost

Quantity	Grade 1	Grade 2	Grade 3	Grade 4	Grade 5
7+	307.04	315.31	323.84	332.61	341.66
1 - 6	331.48	339.75	348.28	357.06	366.10

COM Yardage: ⅔ yd. - price @ GR 1

Weight: 30 lbs

Items Per Carton: 1

Shipping Class: 150

Seat Diameter: 14"



Arch Leg Stool with Drum Seat

300 - 161

Features

30" H x 16" W x 16" D
 3½" Column
 1" Rd. Steel Tubing (16 Gauge)
 #6 Glide
 #801 Swivel

Optional:

Accent Piping (Shown Here)

24" Seat Height at No Cost

Quantity	Grade 1	Grade 2	Grade 3	Grade 4	Grade 5
7+	236.33	243.00	249.89	256.98	264.29
1 - 6	260.77	267.45	274.33	281.43	288.73

COM Yardage: ⅞ yd. - price @ GR 1

Weight: 29 lbs

Items Per Carton: 1

Shipping Class: 150

Seat Diameter: 14"



Arch Leg Stool with Back

300 - 531 SH

Features

30" H x 16" W x 16" D
 2" Sewn Hood Seat
 3½" Column
 1" Rd. Steel Tubing (16 Gauge)
 #6 Glide
 #21 with Cup Swivel

Optional:

Accent Piping (Shown Here)

24" Seat Height at No Cost

Quantity	Grade 1	Grade 2	Grade 3	Grade 4	Grade 5
7+	281.80	289.62	297.68	305.97	314.52
1 - 6	306.25	314.07	322.12	330.41	338.96

COM Yardage: ¾ yd. - price @ GR 1

Weight: 29 lbs

Items Per Carton: 1

Shipping Class: 150

Seat Width: 15"

Standard Chrome Finish & Revolving Seats



*Arch Leg Stool with
Bulged Seat Ring*

300 - 781/46

Features

30" H x 16" W x 16" D
3½" Column
1" Pulled Seat
1" Rd. Steel Tubing (16 Gauge)
#6 Glide
#801 Swivel

Optional:

24" Seat Height at No Cost

Quantity	Grade 1	Grade 2	Grade 3	Grade 4	Grade 5
7+	225.89	231.96	238.21	244.65	251.29
1 - 6	250.33	256.40	262.65	269.10	275.73

COM Yardage: ⅓ yd. - price @ GR 1

Weight: 22 lbs

Items Per Carton: 1

Shipping Class: 150

Seat Diameter: 13"



*Arch Leg Stool
with Back*

300 - 921 / 530

Features

30" H x 16" W x 16" D
3½" Column
1" Pulled Seat
1" Rd. Steel Tubing (16 Gauge)
#6 Glide
#21 Swivel with Cup

Optional:

24" Seat Height at No Cost

Quantity	Grade 1	Grade 2	Grade 3	Grade 4	Grade 5
7+	271.32	278.82	286.56	294.52	302.71
1 - 6	295.76	303.26	311.00	318.96	327.16

COM Yardage: ⅔ yd. - price @ GR 1

Weight: 29 lbs

Items Per Carton: 1

Shipping Class: 150

Seat Width: 15"



*Arch Leg Stool with
"V" Back*

300 - 921 "V"

Features

30" H x 16" W x 16" D
3½" Column
1" Pulled Seat
1" Rd. Steel Tubing (16 Gauge)
#6 Glide
#21 Swivel with Cup

Optional:

24" Seat Height at No Cost

Quantity	Grade 1	Grade 2	Grade 3	Grade 4	Grade 5
7+	295.52	303.75	312.23	320.96	329.95
1 - 6	319.96	328.19	336.67	345.41	354.39

COM Yardage: 1 yd. - price @ GR 1

Weight: 29 lbs

Items Per Carton: 1

Shipping Class: 150

Seat Width: 15"



*Arch Leg Stool with
Channel Back*

300 - 939 CB

Features

30" H x 16" W x 16" D
3½" Column
1" Pulled Seat
1" Rd. Steel Tubing (16 Gauge)
#6 Glide
#21 Swivel with Cup

Optional:

24" Seat Height at No Cost

Quantity	Grade 1	Grade 2	Grade 3	Grade 4	Grade 5
7+	286.60	294.56	302.76	311.21	319.91
1 - 6	311.04	319.01	327.20	335.65	344.35

COM Yardage: ¾ yd. - price @ GR 1

Weight: 29 lbs

Items Per Carton: 1

Shipping Class: 150

Seat Width: 15"

Standard Chrome Finish & Revolving Seats



Single Ring Pyramid
Base Stool

400 - 49 NS

Features

30" H x 16" W x 16" D
1" Pulled Seat
1¼" Rd. Tubing (16 Gauge)
#15 Glide
#18 Swivel

Quantity	Grade 1	Grade 2	Grade 3	Grade 4	Grade 5
7+	197.33	202.05	206.90	211.91	217.07
1 - 6	221.77	226.49	231.34	236.35	241.51

COM Yardage: ⅓ yd. - price @ GR 1 Weight: 23 lbs
Items Per Carton: 1 Shipping Class: 150
Seat Diameter: 14"



Single Ring Pyramid Base
with Back Stool

400 - 49 NSRB

Features

30" H x 16" W x 16" D
1" Pulled Seat
1¼" Rd. Tubing (16 Gauge)
#15 Glide
#18 Swivel

Quantity	Grade 1	Grade 2	Grade 3	Grade 4	Grade 5
7+	269.14	275.79	282.63	289.67	296.93
1 - 6	293.58	300.23	307.07	314.11	321.37

COM Yardage: ¾ yd. - price @ GR 1 Weight: 30 lbs
Items Per Carton: 1 Shipping Class: 150
Seat Diameter: 14"



Single Ring Pyramid
Base Stool

400 - 125

Features

30" H x 16" W x 16" D
1" Pulled Seat
1¼" Rd. Tubing (16 Gauge)
#15 Glide
#18 Swivel

Quantity	Grade 1	Grade 2	Grade 3	Grade 4	Grade 5
7+	191.57	196.41	201.39	206.53	211.82
1 - 6	216.01	220.85	225.83	230.97	236.26

COM Yardage: ⅔ yd. - price @ GR 1 Weight: 23 lbs
Items Per Carton: 1 Shipping Class: 150
Seat Diameter: 14"



Single Ring Pyramid
Stool with Back

400 - 242 WF

Features

30" H x 16" W x 16" D
2" Waterfall Seat
1¼" Rd. Tubing (16 Gauge)
#15 Glide
#20 DBL Plate Swivel

Quantity	Grade 1	Grade 2	Grade 3	Grade 4	Grade 5
7+	276.53	283.93	291.56	299.39	307.46
1 - 6	300.97	308.38	316.00	323.83	331.90

COM Yardage: 1¼ yds. - price @ GR 1 Weight: 37 lbs
Items Per Carton: 1 Shipping Class: 150
Seat Width: 16"

Chrome Finish Only & Revolving Seats



Single Ring Pyramid Base
with Bulged Seat Ring

400 - 781/46

Features

30" H x 16" W x 16" D
1" Pulled Seat
1¼" Rd. Steel Tubing (16 Gauge)
#15 Glide
#18 Swivel

Quantity	Grade 1	Grade 2	Grade 3	Grade 4	Grade 5
7+	195.47	200.14	204.93	209.88	214.98
1 - 6	219.91	224.58	229.37	234.32	239.42

COM Yardage: ⅓ yd. - price @ GR 1

Weight: 23 lbs

Items Per Carton: 1

Shipping Class: 150

Seat Diameter: 13"



Single Ring Pyramid Base
with Grooved Ring

400 - 782

Features

30" H x 16" W x 16" D
1¼" Rd. Steel Tubing (16 Gauge)
Black & Red Stripe at No Cost
#15 Glide
#18 Swivel

Quantity	Grade 1	Grade 2	Grade 3	Grade 4	Grade 5
7+	197.33	202.05	206.90	211.91	217.07
1 - 6	221.77	226.49	231.34	236.35	241.51

COM Yardage: ⅓ yd. - price @ GR 1

Weight: 23 lbs

Items Per Carton: 1

Shipping Class: 150

Seat Diameter: 14"

Optional:

Custom Color Stripes (See pg.93)



Single Ring Pyramid Base
with Malibu Back

400 - 782 RBMB

Features

30" H x 16" W x 16" D
1¼" Rd. Steel Tubing (16 Gauge)
Black & Red Stripe at No Cost
#15 Glide
#18 Swivel

Quantity	Grade 1	Grade 2	Grade 3	Grade 4	Grade 5
7+	293.30	300.66	308.25	316.06	324.11
1 - 6	317.74	325.10	332.69	340.50	348.55

COM Yardage: ¾ yd. - price @ GR 1

Weight: 30 lbs

Items Per Carton: 1

Shipping Class: 150

Seat Diameter: 14"

Optional:

Custom Color Stripes (See pg.93)



Single Ring Pyramid Base
with Handle Back

400 - 921 HB

Features

30" H x 16" W x 16" D
1¼" Rd. Steel Tubing (16 Gauge)
#15 Glide
#20 Swivel

Quantity	Grade 1	Grade 2	Grade 3	Grade 4	Grade 5
7+	292.20	299.82	307.69	315.78	324.12
1 - 6	316.64	324.26	332.13	340.22	348.56

COM Yardage: ¾ yd. - price @ GR 1

Weight: 30 lbs

Items Per Carton: 1

Shipping Class: 150

Seat Width: 15"

Standard Black Base Bottom & Revolving Seats

**500 - 46****Features**

30" H x 16" W x 16" D
3½" Column
#801 Swivel

Optional:

Add \$37.73 for Chrome (Shown Here)
24" Seat Height at No Cost

Quantity	Grade 1	Grade 2	Grade 3	Grade 4	Grade 5
7+	247.93	254.57	261.39	268.42	275.65
1 - 6	272.38	279.01	285.83	292.86	300.10

COM Yardage: ⅓ yd. - price @ GR 1

Weight: 30lbs

Items Per Carton: 1

Shipping Class: 150

Seat Diameter: 14"

**500 - 125****Features**

30" H x 16" W x 16" D
3½" Column
#801 Swivel

Optional:

Add \$37.73 for Chrome
24" Seat Height at No Cost

Quantity	Grade 1	Grade 2	Grade 3	Grade 4	Grade 5
7+	225.75	232.30	239.03	245.97	253.12
1 - 6	250.19	256.74	263.47	270.41	277.56

COM Yardage: ⅔ yd. - price @ GR 1

Weight: 30lbs

Items Per Carton: 1

Shipping Class: 150

Seat Diameter: 14"

**500 - 161****Features**

30" H x 16" W x 16" D
3½" Column
#801 Swivel

Optional:

Add \$37.73 for Chrome
24" Seat Height at No Cost

Quantity	Grade 1	Grade 2	Grade 3	Grade 4	Grade 5
7+	247.19	254.37	261.78	269.40	277.25
1 - 6	271.63	278.82	286.22	293.84	301.70

COM Yardage: ⅞ yd. - price @ GR 1

Weight: 30lbs

Items Per Carton: 1

Shipping Class: 150

Seat Diameter: 14"

**500 - 242 WF****Features**

30" H x 16" W x 16" D
3½" Column
#20 DBL Plate Swivel

Optional:

Add \$37.73 for Chrome
24" Seat Height at No Cost

Quantity	Grade 1	Grade 2	Grade 3	Grade 4	Grade 5
7+	310.23	319.31	328.66	338.28	348.20
1 - 6	334.67	343.75	353.10	362.72	372.65

COM Yardage: 1¼ yds. - price @ GR 1

Weight: 37lbs

Items Per Carton: 1

Shipping Class: 150

Seat Width: 16"

Standard Black Base Bottom & Revolving Seats



500 - 781

Features

30" H x 16" W x 16" D

3½" Column

#801 Swivel

Optional:

Add \$37.73 for Chrome

24" Seat Height at No Cost

Quantity	Grade 1	Grade 2	Grade 3	Grade 4	Grade 5
7+	247.93	254.57	261.39	268.42	275.65
1 - 6	272.38	279.01	285.83	292.86	300.10

COM Yardage: ⅓ yd. - price @ GR 1

Weight: 30 lb

Items Per Carton: 1

Shipping Class: 150

Seat Diameter: 13"



500 - 782

Features

30" H x 16" W x 16" D

3½" Column

Black & Red Stripe at No Cost

#801 Swivel

Optional:

Custom Color Stripes (See pg.93)

Add \$37.73 for Chrome (Shown Here)

24" Seat Height at No Cost

Quantity	Grade 1	Grade 2	Grade 3	Grade 4	Grade 5
7+	249.03	255.70	262.55	269.61	276.89
1 - 6	273.48	280.14	286.99	294.06	301.33

COM Yardage: ⅓ yd. - price @ GR 1

Weight: 30 lb

Items Per Carton: 1

Shipping Class: 150

Seat Diameter: 14"



500 - 782 RB

Features

30" H x 16" W x 16" D

3½" Column

Black & Red Stripe at No Cost

#19 with Cup Swivel

Optional:

Custom Color Stripes (See pg.93)

Add \$37.73 for Chrome (Shown Here)

24" Seat Height at No Cost

Quantity	Grade 1	Grade 2	Grade 3	Grade 4	Grade 5
7+	315.20	323.62	332.28	341.21	350.39
1 - 6	339.64	348.06	356.73	365.65	374.83

COM Yardage: ⅔ yd. - price @ GR 1

Weight: 37 lb

Items Per Carton: 1

Shipping Class: 150

Seat Diameter: 14"



500 - 921

Features

30" H x 16" W x 16" D

3½" Column

#21 with Cup Swivel

Optional:

Add \$37.73 for Chrome (Shown Here)

24" Seat Height at No Cost

Quantity	Grade 1	Grade 2	Grade 3	Grade 4	Grade 5
7+	277.88	285.76	293.88	302.23	310.84
1 - 6	302.33	310.20	318.32	326.67	335.28

COM Yardage: ⅔ yd. - price @ GR 1

Weight: 37 lb

Items Per Carton: 1

Shipping Class: 150

Seat Width: 15"

Econo Stools Have An Industrial Make Up



Econo Stool

751 Econo

Features

30" H x 16" W x 16" D
 1" Pulled Seat
¹³/₁₆" Sq. Steel Tubing (16 Gauge)
 #2 Glide
 Standard Chrome

Optional:

24" Seat Height at No Cost

Quantity	Grade 1	Grade 2	Grade 3	Grade 4	Grade 5
7+	118.78	121.67	124.65	127.73	130.89
1-6	143.22	146.11	149.09	152.17	155.33

COM Yardage: ¹/₃ yd. - price @ GR 1

Weight: 16 lbs

Items Per Carton: 1

Shipping Class: 150

Seat Diameter: 13"



Econo Stool

752 Econo

Features

30" H x 16" W x 16" D
 1" Pulled Seat
¹³/₁₆" Sq. Steel Tubing (16 Gauge)
 #2 Glide
 Standard Chrome

Optional:

24" Seat Height at No Cost

Quantity	Grade 1	Grade 2	Grade 3	Grade 4	Grade 5
7+	121.98	124.97	128.05	131.23	134.50
1-6	146.42	149.41	152.49	155.67	158.94

COM Yardage: ¹/₃ yd. - price @ GR 1

Weight: 16 lbs

Items Per Carton: 1

Shipping Class: 150

Seat Diameter: 13"

ECONO

— Backless Non-Swivel Stool —

Standard Chrome Finish & Revolving Seats

* Specify The Floor Attachment Shown On Pg.94



Classic Fountain Stool

1500 - 46

Features

30" H x 14" W x 14" D

3½" Column

9" Bell Bottom

#801 Swivel

Optional:

Grooved Column (Shown Here: Add \$22.65)

18" or 24" Seat Height at No Cost

Quantity	Grade 1	Grade 2	Grade 3	Grade 4	Grade 5
7+	224.12	230.24	236.54	243.04	249.72
1 - 6	248.56	254.68	260.98	267.48	274.16

COM Yardage: ⅓ yd. - price @ GR 1

Weight: 25 lb

Items Per Carton: Varies

Shipping Class: Head - 85

Seat Diameter: 14"

Base - 70



Classic Fountain Stool
with Drum Seat

1500 - 161

Features

30" H x 14" W x 14" D

3½" Column

9" Bell Bottom

#801 Swivel

Optional:

18" or 24" Seat Height at No Cost

Quantity	Grade 1	Grade 2	Grade 3	Grade 4	Grade 5
7+	237.73	244.56	251.59	258.83	266.30
1 - 6	262.17	269.00	276.03	283.27	290.74

COM Yardage: ⅞ yd. - price @ GR 1

Weight: 19 lb

Items Per Carton: Varies

Shipping Class: Head - 85

Seat Diameter: 14"

Base - 70



Classic Fountain Stool
with Back

1500 - 530

Features

30" H x 15" W x 15" D

3½" Column

9" Bell Bottom

#22 with Cup Return Swivel

Optional:

18" or 24" Seat Height at No Cost

Quantity	Grade 1	Grade 2	Grade 3	Grade 4	Grade 5
7+	263.87	271.25	278.85	286.68	294.74
1 - 6	288.31	295.69	303.29	311.12	319.19

COM Yardage: ¾ yd. - price @ GR 1

Weight: 25 lb

Items Per Carton: 1

Shipping Class: Head - 85

Seat Width: 15"

Base - 70



Classic Fountain Stool
with Bulged Seat Ring

1500 - 781

Features

30" H x 13" W x 13" D

3½" Column

9" Bell Bottom

#801 Swivel

Optional:

18" or 24" Seat Height at No Cost

Footrest (Shown with 606: Add \$98.24)

*Footrest not available on 18"

Quantity	Grade 1	Grade 2	Grade 3	Grade 4	Grade 5
7+	224.14	230.27	236.57	243.06	249.75
1 - 6	248.59	254.71	261.02	267.51	274.19

COM Yardage: ⅓ yd. - price @ GR 1

Weight: 25 lb

Items Per Carton: 1

Shipping Class: Head - 85

Seat Diameter: 13"

Base - 70

Standard Chrome Finish & Revolving Seats

*Specify The Floor Attachment Shown On Pg.94



Classic Fountain Stool
with Grooved Seat Ring

1500 - 782

Features

30" H x 14" W x 14" D

3½" Column

9" Bell Bottom

Black & Red Stripe at No Cost

#801 Swivel

Optional:

Custom Color Stripes (See pg.93)

18" or 24" Seat Height at No Cost

Quantity	Grade 1	Grade 2	Grade 3	Grade 4	Grade 5
7+	226.18	232.36	238.72	245.29	252.04
1-6	250.62	256.80	263.16	269.73	276.48

COM Yardage: ⅓ yd. - price @ GR 1 Weight: 25lb
 Items Per Carton: Varies Shipping Class: Head - 85
 Seat Diameter: 14" Base - 70



Classic Fountain Stool
with Back & Grooved
Seat Ring

1500 - 782 RB

Features

30" H x 14" W x 14" D

3½" Column

9" Bell Bottom

Black & Red Stripe at No Cost

#19 with Cup Return Swivel

Optional:

Custom Color Stripes (See pg.93)

18" or 24" Seat Height at No Cost

Quantity	Grade 1	Grade 2	Grade 3	Grade 4	Grade 5
7+	302.84	311.09	319.60	328.35	337.36
1-6	327.28	335.53	344.04	352.79	361.80

COM Yardage: ⅔ yd. - price @ GR 1 Weight: 30lb
 Items Per Carton: Varies Shipping Class: Head - 85
 Seat Diameter: 14" Base - 70



Classic Fountain Stool
with Back

1500 - 921

Features

30" H x 15" W x 15" D

3½" Column

9" Bell Bottom

#22 with Cup Return Swivel

Optional:

18" or 24" Seat Height at No Cost

Footrest (Shown with 505: Add \$98.91)

*Footrest not available on 18"

Quantity	Grade 1	Grade 2	Grade 3	Grade 4	Grade 5
7+	263.87	271.25	278.85	286.68	294.74
1-6	288.31	295.69	303.29	311.12	319.19

COM Yardage: ¾ yd. - price @ GR 1 Weight: 25lb
 Items Per Carton: 1 Shipping Class: Head - 85
 Seat Width: 15" Base - 70



Classic Fountain Stool
with Channel Back

1500 - 939 CB

Features

30" H x 15" W x 15" D

3½" Column

9" Bell Bottom

#22 with Cup Return Swivel

Optional:

18" or 24" Seat Height at No Cost

Quantity	Grade 1	Grade 2	Grade 3	Grade 4	Grade 5
7+	289.57	297.74	306.13	314.78	323.69
1-6	314.02	322.18	330.57	339.22	348.13

COM Yardage: 1 yd. - price @ GR 1 Weight: 26lb
 Items Per Carton: Varies Shipping Class: Head - 85
 Seat Width: 15" Base - 70

Standard Chrome Finish & Revolving Seats

* Standard Red & Black Teardrop Colors

* Specify The Floor Attachment Shown On Pg.94



Classic Teardrop Stool
with Smooth Ring

1700 - 46

Features

30" H x 14" W x 14" D
3 1/2" Column
9" Bell Bottom
#801 Swivel

Optional:

Grooved Column (Shown Here: Add \$22.65)
18" or 24" Seat Height at No Cost

Quantity	Grade 1	Grade 2	Grade 3	Grade 4	Grade 5
7+	241.50	248.15	254.99	262.03	269.29
1 - 6	265.94	272.59	279.43	286.47	293.73

COM Yardage: 1/3 yd. - price @ GR 1

Weight: 18 lbs

Items Per Carton: Varies

Shipping Class: Head - 85
Base - 70

Seat Diameter: 14"



Classic Teardrop Stool
with Drum Seat

1700 - 161

Features

30" H x 14" W x 14" D
3 1/2" Column
9" Bell Bottom
#801 Swivel

Optional:

18" or 24" Seat Height at No Cost

Quantity	Grade 1	Grade 2	Grade 3	Grade 4	Grade 5
7+	255.15	262.51	270.08	277.88	285.91
1 - 6	279.60	286.95	294.52	302.32	310.35

COM Yardage: 1 2/3 yd. - price @ GR 1

Weight: 19 lbs

Items Per Carton: 1

Shipping Class: Head - 85
Base - 70

Seat Diameter: 14"



Classic Teardrop Stool
with Bulged Seat Ring

1700 - 781

Features

30" H x 13" W x 13" D
3 1/2" Column
9" Bell Bottom
#801 Swivel

Optional:

18" or 24" Seat Height at No Cost
Footrest (Shown is 606: Add \$98.24)

*Footrest not available on 18"

Quantity	Grade 1	Grade 2	Grade 3	Grade 4	Grade 5
7+	241.52	248.17	255.01	262.06	269.31
1 - 6	265.97	272.61	279.45	286.50	293.75

COM Yardage: 1/3 yd. - price @ GR 1

Weight: 22 lbs

Items Per Carton: Varies

Shipping Class: Head - 85
Base - 70

Seat Diameter: 13"



Classic Teardrop Stool
with Grooved Seat Ring

1700 - 782

Features

30" H x 14" W x 14" D
3 1/2" Column
9" Bell Bottom
Black & Red Stripe at No Cost
#801 Swivel

Optional:

Custom Color Stripes (See pg.93)
18" or 24" Seat Height at No Cost

Quantity	Grade 1	Grade 2	Grade 3	Grade 4	Grade 5
7+	243.64	250.34	257.24	264.35	271.68
1 - 6	268.08	274.78	281.69	288.79	296.12

COM Yardage: 1/3 yd. - price @ GR 1

Weight: 25 lbs

Items Per Carton: Varies

Shipping Class: Head - 85
Base - 70

Seat Diameter: 14"

Standard Chrome Finish & Revolving Seats

* Standard Red & Black Teardrop Colors

* Specify The Floor Attachment Shown On Pg.94



Classic Teardrop Stool
with Elite Back &
Grooved Seat Ring

1700 - 782 RB - EL**Features**

30" H x 14" W x 14" D

3½" Column

9" Bell Bottom

Black & Red Stripe at No Cost

#801 Swivel

Optional:

Custom Color Stripes (See Below)

18" or 24" Seat Height at No Cost

Quantity	Grade 1	Grade 2	Grade 3	Grade 4	Grade 5
7+	344.44	353.21	362.25	371.56	381.15
1-6	368.89	377.65	386.70	396.00	405.59

COM Yardage: ⅔ yd. - price @ GR 1

Weight: 30lbs

Items Per Carton: Varies

Shipping Class: Head -85
Base -70

Seat Diameter: 14"



Classic Teardrop Stool
with Smooth Back

1700 - 921**Features**

30" H x 15" W x 15" D

3½" Column

9" Bell Bottom

#22 with Cup Return Swivel

Optional:

Grooved Column (Shown Here: Add \$22.65)

18" or 24" Seat Height at No Cost

Quantity	Grade 1	Grade 2	Grade 3	Grade 4	Grade 5
7+	281.27	289.17	297.31	305.70	314.34
1-6	305.71	313.61	321.61	330.14	338.78

COM Yardage: ⅔ yd. - price @ GR 1

Weight: 30lbs

Items Per Carton: Varies

Shipping Class: Head -85
Base -70

Seat Width: 15"



Classic Teardrop Stool
with "V" Back

1700 - 921 "V"**Features**

30" H x 15" W x 15" D

3½" Column

9" Bell Bottom

#22 with Cup Return Swivel

Optional:

Grooved Column (Shown Here: Add \$22.65)

18" or 24" Seat Height at No Cost

Quantity	Grade 1	Grade 2	Grade 3	Grade 4	Grade 5
7+	305.51	314.15	323.04	332.19	341.63
1-6	329.96	338.59	347.48	356.63	366.07

COM Yardage: ¼ yd. - price @ GR 1

Weight: 30lbs

Items Per Carton: 1

Shipping Class: Head -85
Base -70

Seat Width: 15"

Custom 1700 Features

Special Heights

\$20.72

Custom Color Pinstriping1-3 pcs: \$69.84 flat charge
4+ pcs: \$15.20 each**Grooved Columns**

\$22.65

Teardrop Colors

(white, blue, pink, and yellow)

\$19.54 each

*Minimum order of 7 stools for colors
other than red or black

*Red and black are standard

Available In all powder paint colors



1500 & 1700 Attachments

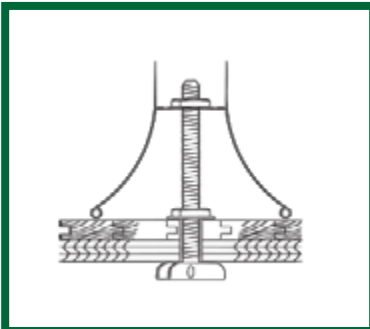

Type "A"

Type "A" Floor Attachment

Utilized to secure the 1500 - 1700 series fountain stool or H - Series Table Base through a wooden floor (*Floor not to exceed 5" in thickness*) by means of a toggle bolt.

24.71

With purchase of stool

FREE

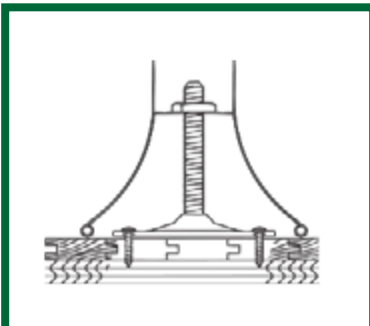

Type "B"

Type "B" Floor Attachment

Utilized to secure the 1500 - 1700 series fountain stool or H - series table base to a wooden floor by means of an anchor plate.

24.71

With purchase of stool

FREE

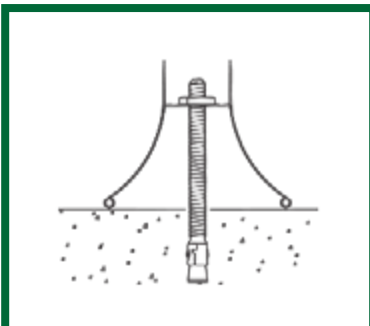

Type "C"

Type "C" Floor Attachment

Utilized to secure the 1500 - 1700 series fountain stool or H - series table base into a composite floor by means of an expansion shell.

24.71

With purchase of stool

FREE

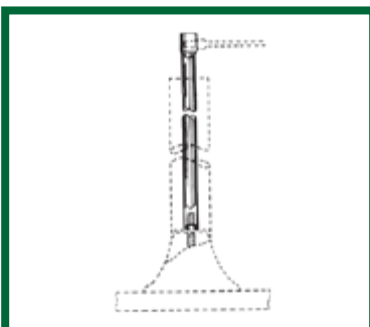

Wrench

Wrench Floor Attachment

Utilized to tighten the 1500 - 1700 series fountain stool or H - Series Table Base to the floor.

24.71

With purchase of stool

FREE

Footrest

*Footrest Not Available On 18" Stools



404 Footring

404 Footring

Brings the contemporary styling of the 500 series to the 1500 & 1700 series fountain stool. Chrome finish is standard.

16" ring

140.14



505 Footrest

505 Footrest

Offers a triangular, contoured cast version to the 1500 & 1700 soda fountain stool.

98.91



606 Footrest

606 Footrest

Displays an attractive, inexpensive addition to the 1500 & 1700 soda fountain series along with 1800 base stools. 1800 stool base footrest are painted only.

98.24



707 Footrest

707 Footrest

Displays an inexpensive, nostalgic addition to the 1500 - 1700 series fountain stool.

98.24

Glides

Please note: Over the years, some models may have changed from one glide style to another. When requesting replacement glides for your particular situation, compare the glide that you currently have with our illustrations. Should your glide look different than one of those illustrated please feel free to call CA/B

<p>Stacker</p>  <p>#1</p> <p>1.72</p>	<p>Stack Chair</p>  <p>#2</p> <p>1.16</p>	<p>265 & 921</p>  <p>#3</p> <p>2.04</p>	<p>921 & 934</p>  <p>#6</p> <p>1.72</p>	<p>A & D Bases</p>  <p>#7</p> <p>1.72</p>
<p>Metal Glide $\frac{13}{16}$" or 1" Square <i>Nylon bottom available on $\frac{13}{16}$"</i></p>	<p>Plastic Glide $\frac{13}{16}$" Square</p>	<p>Metal Glide $\frac{3}{4}$" and 1" Round</p>	<p>Metal Glide 1" Round</p>	<p>Metal Glide/Nylon Adjustable $1\frac{1}{16}$" Diameter $\frac{1}{4}$-20 Thread</p>
<p>All Bases</p>  <p>#9 <i>Self Leveling</i></p> <p>4.31</p>	<p>B & C Bases</p>  <p>#10</p> <p>1.16</p>	<p>264 & 215</p>  <p>#11</p> <p>1.16</p>	<p>Metal Parlor</p>  <p>#13 <i>Standard</i></p> <p>1.16</p>	<p>Nylon Parlor</p>  <p>#13</p> <p>1.16</p>
<p>Plastic Glide $1\frac{3}{16}$" Diameter $\frac{1}{4}$-20 thread</p>	<p>Plastic Glide Adjustable 1" Diameter $\frac{1}{4}$-20 thread</p>	<p>Black Acrylic Glide 1" Diameter for 16 gauge</p>	<p>Metal Glide $\frac{7}{8}$" Round platform glide</p>	<p>Nylon Glide $\frac{7}{8}$" Round platform glide</p>
<p>Omni & Spectrum</p>  <p>#15</p> <p>1.16</p>	<p>LSC, INN, OX</p>  <p>#18</p> <p>1.16</p>	<p>Glide Cap</p>  <p>#1/6</p> <p>1.16</p>	<p>884</p>  <p>#17</p> <p>1.16</p>	<p>885</p>  <p>#16</p> <p>1.16</p>
<p>Metal Glide/Nylon $1\frac{1}{4}$" Round</p>	<p>Butyrate Glide $1\frac{1}{4}$" square 16 gauge - black</p>	<p>Retread Heavy Duty Nylon</p>		

Swivels

Please note: Over the years, some models may have changed from one swivel style to another. When requesting replacement swivels for your particular situation, compare the swivel that you currently have with our illustrations. Should your swivel look different than one of those illustrated please feel free to call CA/B

215 & 265 Stool

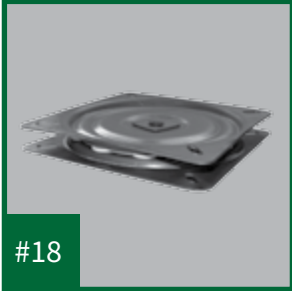

#18

28.96

Double - plate, flat swivel for seat without backs.

Call (478) 320-2502



#19

33.24

Single - plate, flat swivel.

215 & 265

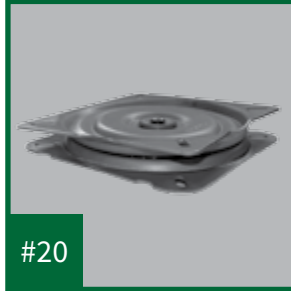

#20

28.96

Double - plate, 3° tilting swivel.

300,264,1500 & 1700 Stools



#21
cup

33.24

Single - plate, 3° tilting swivel with cup.

1500 - 1700 Stools w/ Backs



#22
studs

51.00

Single - plate, 3° tilting, return swivel with studs.

1500 - 1700 Stools w/ Backs



#22
cup

51.00

Single - plate, 3° tilting, return swivel with cup.

1800 Stools



#22
DP

51.00

Double - plate, 3° tilting, return swivel with double plate.

264,300,1500 & 1700 Stools



#801

33.24

Flat swivel, with cup.



Swivel, 3 bolt pattern



Swivel, 4 bolt pattern

Modular Series



M2W

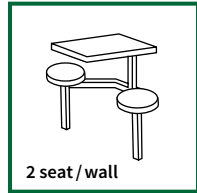

Includes 2 seat unit with 24x24 table top

Specify upholstery:
Up to grade 3

Specify upper finish:
Any powder coat

Specify lower finish:
Satin black standard, or powder coat

Specify:
Bolt down or core drill

M4W

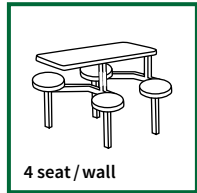

Includes 4 seat unit with 24x48 table top

Specify upholstery:
Up to grade 3

Specify upper finish:
Any powder coat

Specify lower finish:
Satin black standard, or powder coat

Specify:
Bolt down or core drill

M4I

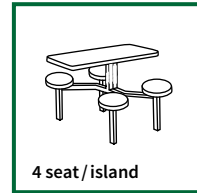

Includes 4 seat unit with 24x50 table top

Specify upholstery:
Up to grade 3

Specify upper finish:
Any powder coat

Specify lower finish:
Satin black standard, or powder coat

Specify:
Bolt down or core drill

M6W

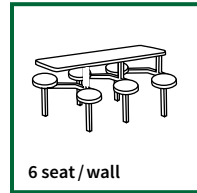

Includes 6 seat unit with 24x76 table top

Specify upholstery:
Up to grade 3

Specify upper finish:
Any powder coat

Specify lower finish:
Satin black standard, or powder coat

Specify:
Bolt down or core drill



With Table Top <i>Specify: BN or BGA-125</i>	With Table Top <i>Specify: BN or BGA-125</i>	With Table Top <i>Specify: BN or BGA-125</i>	With Table Top <i>Specify: BN or BGA-125</i>
854.32	1,687.19	1,664.17	2,504.61
Without Table 770.97	Without Table 1,520.52	Without Table 1,455.83	Without Table 2,171.51



With Table Top <i>Specify: BN or BGA-125</i>	With Table Top <i>Specify: BN or BGA-125</i>	With Table Top <i>Specify: BN or BGA-125</i>	With Table Top <i>Specify: BN or BGA-125</i>
854.32	1,687.19	1,664.17	2,504.61
Without Table 770.97	Without Table 1,520.52	Without Table 1,455.83	Without Table 2,171.51



With Table Top <i>Specify: BN or BGA-125</i>	With Table Top <i>Specify: BN or BGA-125</i>	With Table Top <i>Specify: BN or BGA-125</i>	With Table Top <i>Specify: BN or BGA-125</i>
854.32	1,687.19	1,664.17	2,504.61
Without Table 770.97	Without Table 1,520.52	Without Table 1,455.83	Without Table 2,171.51

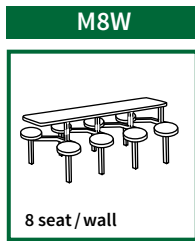

Includes 8 seat unit with 24 x 102 table top

Specify upholstery:
Up to grade 3

Specify upper finish:
Any powder coat

Specify lower finish:
Satin black standard, or powder coat

Specify:
Bolt down or core drill

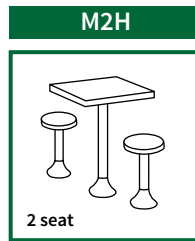

Includes 2 seat unit with 24 x 24 table top

Specify upholstery:
Up to grade 3

Specify upper finish:
Any powder coat

Specify lower finish:
Satin black standard, or powder coat

Specify:
Bolt down or core drill
(No bell)

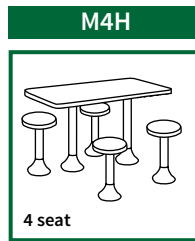

Includes 4 seat unit with 24 x 48 table top

Specify upholstery:
Up to grade 3

Specify upper finish:
Any powder coat

Specify lower finish:
Satin black standard, or powder coat

Specify:
Bolt down or core drill
(No bell)

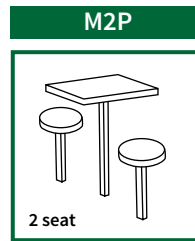

Includes 2 seat unit with 24 x 24 table top

Specify upholstery:
Up to grade 3

Specify upper finish:
Any powder coat

Specify lower finish:
Satin black standard, or powder coat

Core drill only

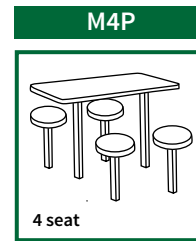

Includes 4 seat unit with 24 x 48 table top

Specify upholstery:
Up to grade 3

Specify upper finish:
Any powder coat

Specify lower finish:
Satin black standard, or powder coat

Core drill only

With Table Top Specify: BN or BGA-125	With Table Top Specify: BN or BGA-125	With Table Top Specify: BN or BGA-125	With Table Top Specify: BN or BGA-125	With Table Top Specify: BN or BGA-125
3,321.03	843.57	1,687.11	768.34	1,536.70
Without Table	Without Table	Without Table	Without Table	Without Table
2,904.35	760.21	1,520.44	685.00	1,370.04

With Table Top Specify: BN or BGA-125	With Table Top Specify: BN or BGA-125	With Table Top Specify: BN or BGA-125	With Table Top Specify: BN or BGA-125	With Table Top Specify: BN or BGA-125
3,321.03	843.57	1,687.11	768.34	1,536.70
Without Table	Without Table	Without Table	Without Table	Without Table
2,904.35	760.21	1,520.44	685.00	1,370.04

With Table Top Specify: BN or BGA-125	With Table Top Specify: BN or BGA-125	With Table Top Specify: BN or BGA-125	With Table Top Specify: BN or BGA-125	With Table Top Specify: BN or BGA-125
3,321.03	843.57	1,687.11	768.34	1,536.70
Without Table	Without Table	Without Table	Without Table	Without Table
2,904.35	760.21	1,520.44	685.00	1,370.04



M2W

2 seat / wall

Includes 2 seat unit with 24 x 24 table top
 Specify upholstery:
Up to grade 3
 Specify upper finish:
Any powder coat
 Specify lower finish:
Satin black standard, or powder coat
 Specify:
Bolt down or core drill

M4W

4 seat / wall

Includes 4 seat unit with 24 x 48 table top
 Specify upholstery:
Up to grade 3
 Specify upper finish:
Any powder coat
 Specify lower finish:
Satin black standard, or powder coat
 Specify:
Bolt down or core drill

M4I

4 seat / island

Includes 4 seat unit with 24 x 50 table top
 Specify upholstery:
Up to grade 3
 Specify upper finish:
Any powder coat
 Specify lower finish:
Satin black standard, or powder coat
 Specify:
Bolt down or core drill

M6W

6 seat / wall

Includes 6 seat unit with 24 x 76 table top
 Specify upholstery:
Up to grade 3
 Specify upper finish:
Any powder coat
 Specify lower finish:
Satin black standard, or powder coat
 Specify:
Bolt down or core drill

Paint Only
X - 51 Head

With Table Top <i>Specify: BN or BGA - 125</i>	With Table Top <i>Specify: BN or BGA - 125</i>	With Table Top <i>Specify: BN or BGA - 125</i>	With Table Top <i>Specify: BN or BGA - 125</i>
614.00	1,206.54	1,183.50	1,783.33
Without Table 530.66	Without Table 1,039.85	Without Table 975.17	Without Table 1,450.28

X - 52 Head

With Table Top <i>Specify: BN or BGA - 125</i>	With Table Top <i>Specify: BN or BGA - 125</i>	With Table Top <i>Specify: BN or BGA - 125</i>	With Table Top <i>Specify: BN or BGA - 125</i>
768.27	1,515.14	1,492.11	2,246.50
Without Table 684.96	Without Table 1,348.47	Without Table 1,283.76	Without Table 1,913.15



X - 53 Head

With Table Top <i>Specify: BN or BGA - 125</i>	With Table Top <i>Specify: BN or BGA - 125</i>	With Table Top <i>Specify: BN or BGA - 125</i>	With Table Top <i>Specify: BN or BGA - 125</i>
768.27	1,515.14	1,492.11	2,246.50
Without Table 684.96	Without Table 1,348.47	Without Table 1,283.76	Without Table 1,913.15

*Limited supply

X - 55 Head

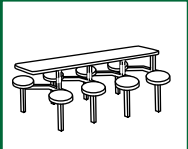
With Table Top <i>Specify: BN or BGA - 125</i>	With Table Top <i>Specify: BN or BGA - 125</i>	With Table Top <i>Specify: BN or BGA - 125</i>	With Table Top <i>Specify: BN or BGA - 125</i>
768.27	1,515.14	1,492.11	2,246.50
Without Table 684.96	Without Table 1,348.47	Without Table 1,283.76	Without Table 1,913.15

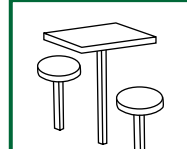
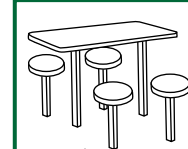
M8W	M2H	M4H	M2P	M4P
				
8 seat / wall	2 seat	4 seat	2 seat	4 seat
Includes 8 seat unit with 24 x 102 table top	Includes 2 seat unit with 24 x 24 table top	Includes 4 seat unit with 24 x 48 table top	Includes 2 seat unit with 24 x 24 table top	Includes 4 seat unit with 24 x 48 table top
Specify upholstery: Up to grade 3	Specify upholstery: Up to grade 3	Specify upholstery: Up to grade 3	Specify upholstery: Up to grade 3	Specify upholstery: Up to grade 3
Specify upper finish: Any powder coat	Specify upper finish: Any powder coat	Specify upper finish: Any powder coat	Specify upper finish: Any powder coat	Specify upper finish: Any powder coat
Specify lower finish: Satin black standard, or powder coat	Specify lower finish: Satin black standard, or powder coat	Specify lower finish: Satin black standard, or powder coat	Specify lower finish: Satin black standard, or powder coat	Specify lower finish: Satin black standard, or powder coat
Specify: Bolt down or core drill	Specify: Bolt down or core drill (No bell)	Specify: Bolt down or core drill (No bell)	Specify: Core drill only	Specify: Core drill only

With Table Top Specify: BN or BGA-125	With Table Top Specify: BN or BGA-125	With Table Top Specify: BN or BGA-125	With Table Top Specify: BN or BGA-125	With Table Top Specify: BN or BGA-125
2,397.63	584.46	1,096.93	528.02	1,056.04
Without Table 1,981.50	Without Table 465.15	Without Table 930.28	Without Table 444.69	Without Table 889.37

With Table Top Specify: BN or BGA-125	With Table Top Specify: BN or BGA-125	With Table Top Specify: BN or BGA-125	With Table Top Specify: BN or BGA-125	With Table Top Specify: BN or BGA-125
2,948.92	702.75	1,409.99	682.32	1,364.63
Without Table 2,532.26	Without Table 619.43	Without Table 1,243.31	Without Table 598.98	Without Table 1,197.94

With Table Top Specify: BN or BGA-125	With Table Top Specify: BN or BGA-125	With Table Top Specify: BN or BGA-125	With Table Top Specify: BN or BGA-125	With Table Top Specify: BN or BGA-125
2,948.92	702.75	1,409.99	682.32	1,364.63
Without Table 2,532.26	Without Table 619.43	Without Table 1,243.31	Without Table 598.98	Without Table 1,197.94

With Table Top Specify: BN or BGA-125	With Table Top Specify: BN or BGA-125	With Table Top Specify: BN or BGA-125	With Table Top Specify: BN or BGA-125	With Table Top Specify: BN or BGA-125
2,948.92	702.75	1,409.99	682.32	1,364.63
Without Table 2,532.26	Without Table 619.43	Without Table 1,243.31	Without Table 598.98	Without Table 1,197.94



M2W

2 seat / wall

Includes 2 seat unit with 24 x 24 table top
 Specify upholstery:
Up to grade 3
 Specify upper finish:
Any powder coat
 Specify lower finish:
Satin black standard, or powder coat
 Specify:
Bolt down or core drill

M4W

4 seat / wall

Includes 4 seat unit with 24 x 48 table top
 Specify upholstery:
Up to grade 3
 Specify upper finish:
Any powder coat
 Specify lower finish:
Satin black standard, or powder coat
 Specify:
Bolt down or core drill

M4I

4 seat / island

Includes 4 seat unit with 24 x 50 table top
 Specify upholstery:
Up to grade 3
 Specify upper finish:
Any powder coat
 Specify lower finish:
Satin black standard, or powder coat
 Specify:
Bolt down or core drill

M6W

6 seat / wall

Includes 6 seat unit with 24 x 76 table top
 Specify upholstery:
Up to grade 3
 Specify upper finish:
Any powder coat
 Specify lower finish:
Satin black standard, or powder coat
 Specify:
Bolt down or core drill

46 Head

With Table Top <i>Specify: BN or BGA-125</i>	With Table Top <i>Specify: BN or BGA-125</i>	With Table Top <i>Specify: BN or BGA-125</i>	With Table Top <i>Specify: BN or BGA-125</i>
615.01	1,159.18	1,110.95	1,839.06
Without Table 549.16	Without Table 1,076.83	Without Table 1,012.15	Without Table 1,505.72

125 Head

With Table Top <i>Specify: BN or BGA-125</i>	With Table Top <i>Specify: BN or BGA-125</i>	With Table Top <i>Specify: BN or BGA-125</i>	With Table Top <i>Specify: BN or BGA-125</i>
595.01	1,119.18	1,070.95	1,779.06
Without Table 529.16	Without Table 1,036.83	Without Table 972.15	Without Table 1,445.72

781 Head

With Table Top <i>Specify: BN or BGA-125</i>	With Table Top <i>Specify: BN or BGA-125</i>	With Table Top <i>Specify: BN or BGA-125</i>	With Table Top <i>Specify: BN or BGA-125</i>
615.01	1,159.18	1,110.95	1,839.06
Without Table 549.16	Without Table 1,076.83	Without Table 1,012.15	Without Table 1,505.72

782 Head

With Table Top <i>Specify: BN or BGA-125</i>	With Table Top <i>Specify: BN or BGA-125</i>	With Table Top <i>Specify: BN or BGA-125</i>	With Table Top <i>Specify: BN or BGA-125</i>
615.01	1,159.18	1,110.95	1,839.06
Without Table 549.16	Without Table 1,076.83	Without Table 1,012.15	Without Table 1,505.72

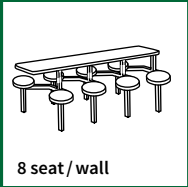
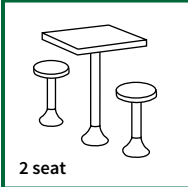
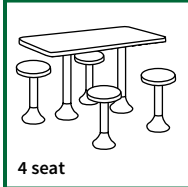
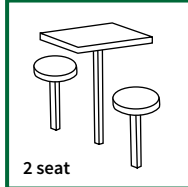
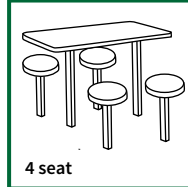
M8W	M2H	M4H	M2P	M4P
				
8 seat / wall	2 seat	4 seat	2 seat	4 seat
Includes 8 seat unit with 24 x 102 table top	Includes 2 seat unit with 24 x 24 table top	Includes 4 seat unit with 24 x 48 table top	Includes 2 seat unit with 24 x 24 table top	Includes 4 seat unit with 24 x 48 table top
Specify upholstery: <i>Up to grade 3</i>	Specify upholstery: <i>Up to grade 3</i>	Specify upholstery: <i>Up to grade 3</i>	Specify upholstery: <i>Up to grade 3</i>	Specify upholstery: <i>Up to grade 3</i>
Specify upper finish: <i>Any powder coat</i>	Specify upper finish: <i>Any powder coat</i>	Specify upper finish: <i>Any powder coat</i>	Specify upper finish: <i>Any powder coat</i>	Specify upper finish: <i>Any powder coat</i>
Specify lower finish: <i>Satin black standard, or powder coat</i>	Specify lower finish: <i>Satin black standard, or powder coat</i>	Specify lower finish: <i>Satin black standard, or powder coat</i>	Specify lower finish: <i>Satin black standard, or powder coat</i>	Specify lower finish: <i>Satin black standard, or powder coat</i>
Specify: <i>Bolt down or core drill</i>	Specify: <i>Bolt down or core drill (No bell)</i>	Specify: <i>Bolt down or core drill (No bell)</i>	Specify: <i>Core drill only</i>	Specify: <i>Core drill only</i>

With Table Top <i>Specify: BN or BGA - 125</i>	With Table Top <i>Specify: BN or BGA - 125</i>	With Table Top <i>Specify: BN or BGA - 125</i>	With Table Top <i>Specify: BN or BGA - 125</i>	With Table Top <i>Specify: BN or BGA - 125</i>
2,433.64	662.24	1,318.51	546.49	1,093.71
Without Table 2,016.95	Without Table 578.89	Without Table 1,151.79	Without Table 463.17	Without Table 926.35

With Table Top <i>Specify: BN or BGA - 125</i>	With Table Top <i>Specify: BN or BGA - 125</i>	With Table Top <i>Specify: BN or BGA - 125</i>	With Table Top <i>Specify: BN or BGA - 125</i>	With Table Top <i>Specify: BN or BGA - 125</i>
2,353.64	642.24	1,278.51	526.49	1,053.71
Without Table 1,936.95	Without Table 558.89	Without Table 1,111.79	Without Table 443.17	Without Table 886.35

With Table Top <i>Specify: BN or BGA - 125</i>	With Table Top <i>Specify: BN or BGA - 125</i>	With Table Top <i>Specify: BN or BGA - 125</i>	With Table Top <i>Specify: BN or BGA - 125</i>	With Table Top <i>Specify: BN or BGA - 125</i>
2,433.64	662.24	1,318.51	546.49	1,093.71
Without Table 2,016.95	Without Table 578.89	Without Table 1,151.79	Without Table 463.17	Without Table 926.35

With Table Top <i>Specify: BN or BGA - 125</i>	With Table Top <i>Specify: BN or BGA - 125</i>	With Table Top <i>Specify: BN or BGA - 125</i>	With Table Top <i>Specify: BN or BGA - 125</i>	With Table Top <i>Specify: BN or BGA - 125</i>
2,433.64	662.24	1,318.51	546.49	1,093.71
Without Table 2,016.95	Without Table 578.89	Without Table 1,151.79	Without Table 463.17	Without Table 926.35



Includes 2 seat unit with 24 x 24 table top

Specify upholstery:
Up to grade 3

Specify upper finish:
Any powder coat

Specify lower finish:
Satin black standard, or powder coat

Specify:
Bolt down or core drill



Includes 4 seat unit with 24 x 48 table top

Specify upholstery:
Up to grade 3

Specify upper finish:
Any powder coat

Specify lower finish:
Satin black standard, or powder coat

Specify:
Bolt down or core drill



Includes 4 seat unit with 24 x 50 table top

Specify upholstery:
Up to grade 3

Specify upper finish:
Any powder coat

Specify lower finish:
Satin black standard, or powder coat

Specify:
Bolt down or core drill

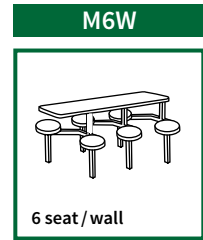

Includes 6 seat unit with 24 x 76 table top

Specify upholstery:
Up to grade 3

Specify upper finish:
Any powder coat

Specify lower finish:
Satin black standard, or powder coat

Specify:
Bolt down or core drill

125 RB Head

With Table Top <i>Specify: BN or BGA-125</i>	With Table Top <i>Specify: BN or BGA-125</i>	With Table Top <i>Specify: BN or BGA-125</i>	With Table Top <i>Specify: BN or BGA-125</i>
718.48	1,366.11	1,317.58	2,149.44
Without Table 652.61	Without Table 1,283.76	Without Table 1,218.77	Without Table 1,816.11

782 RB Head

With Table Top <i>Specify: BN or BGA-125</i>	With Table Top <i>Specify: BN or BGA-125</i>	With Table Top <i>Specify: BN or BGA-125</i>	With Table Top <i>Specify: BN or BGA-125</i>
753.80	1,436.75	1,388.22	2,255.40
Without Table 687.93	Without Table 1,354.40	Without Table 1,289.41	Without Table 1,922.07

Add \$24.17 for "V"

921 Head

With Table Top <i>Specify: BN or BGA-125</i>	With Table Top <i>Specify: BN or BGA-125</i>	With Table Top <i>Specify: BN or BGA-125</i>	With Table Top <i>Specify: BN or BGA-125</i>
733.82	1,396.79	1,348.26	2,195.46
Without Table 667.95	Without Table 1,314.44	Without Table 1,249.45	Without Table 1,862.13

939 CBWF Head

With Table Top <i>Specify: BN or BGA-125</i>	With Table Top <i>Specify: BN or BGA-125</i>	With Table Top <i>Specify: BN or BGA-125</i>	With Table Top <i>Specify: BN or BGA-125</i>
750.27	1,413.25	1,364.72	2,211.92
Without Table 684.40	Without Table 1,330.89	Without Table 1,265.57	Without Table 1,878.59

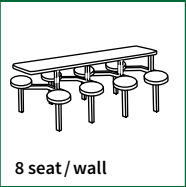
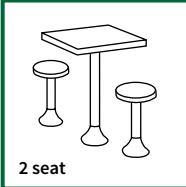
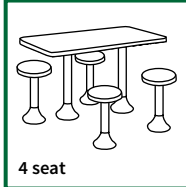
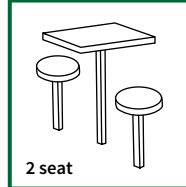
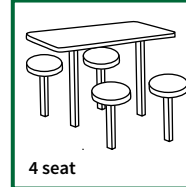
M8W	M2H	M4H	M2P	M4P
				
8 seat / wall	2 seat	4 seat	2 seat	4 seat
Includes 8 seat unit with 24 x 102 table top	Includes 2 seat unit with 24 x 24 table top	Includes 4 seat unit with 24 x 48 table top	Includes 2 seat unit with 24 x 24 table top	Includes 4 seat unit with 24 x 48 table top
Specify upholstery: Up to grade 3	Specify upholstery: Up to grade 3	Specify upholstery: Up to grade 3	Specify upholstery: Up to grade 3	Specify upholstery: Up to grade 3
Specify upper finish: Any powder coat	Specify upper finish: Any powder coat	Specify upper finish: Any powder coat	Specify upper finish: Any powder coat	Specify upper finish: Any powder coat
Specify lower finish: Satin black standard, or powder coat	Specify lower finish: Satin black standard, or powder coat	Specify lower finish: Satin black standard, or powder coat	Specify lower finish: Satin black standard, or powder coat	Specify lower finish: Satin black standard, or powder coat
Specify: Bolt down or core drill	Specify: Bolt down or core drill (No bell)	Specify: Bolt down or core drill (No bell)	Core drill only	Core drill only

With Table Top	With Table Top	With Table Top	With Table Top	With Table Top
Specify: BN or BGA-125	Specify: BN or BGA-125	Specify: BN or BGA-125	Specify: BN or BGA-125	Specify: BN or BGA-125
2,847.47	786.25	1,572.33	655.68	1,299.94
Without Table	Without Table	Without Table	Without Table	Without Table
2,430.80	702.97	1,405.62	572.35	1,133.25

With Table Top	With Table Top	With Table Top	With Table Top	With Table Top
Specify: BN or BGA-125	Specify: BN or BGA-125	Specify: BN or BGA-125	Specify: BN or BGA-125	Specify: BN or BGA-125
2,988.75	821.57	1,642.97	691.00	1,370.58
Without Table	Without Table	Without Table	Without Table	Without Table
2,572.08	738.29	1,476.26	607.67	1,203.89

With Table Top	With Table Top	With Table Top	With Table Top	With Table Top
Specify: BN or BGA-125	Specify: BN or BGA-125	Specify: BN or BGA-125	Specify: BN or BGA-125	Specify: BN or BGA-125
2,908.93	801.59	1,603.01	671.02	1,330.62
Without Table	Without Table	Without Table	Without Table	Without Table
2,492.16	718.31	1,436.30	587.69	1,163.93

With Table Top	With Table Top	With Table Top	With Table Top	With Table Top
Specify: BN or BGA-125	Specify: BN or BGA-125	Specify: BN or BGA-125	Specify: BN or BGA-125	Specify: BN or BGA-125
2,925.29	818.03	1,619.48	716.92	1,347.07
Without Table	Without Table	Without Table	Without Table	Without Table
2,508.62	734.75	1,452.75	604.15	1,180.39

Stool Heads (HD)

*Wood Seat Add 61.88. Pricing Up To Grade 3

INN - 2120 (HD)



262.21

INN - 2220 (HD)



230.41

INN - 2320 (HD)



251.45

INN - 2420 (HD)



230.41

INN - 2520 (HD)



230.41

INN - 2620 (HD)



237.76

*Shown with optional
wood seat

LSC - 250 (HD)



183.17

LSC - 350 (HD)



183.94

LSC - 450 (HD)



189.04

LSC - 475 (HD)



189.04

LSC - 501 (HD)



218.35

*Shown with optional
wood seat

LSC - 550 (HD)



218.35

LSC - 575 (HD)



218.35

LSC - 600 (HD)



218.35

LSC - 650 (HD)



195.37

LSC - 750 (HD)



189.51

*Shown with optional
wood seat

OX - 10 (HD)



258.47

OX - 20 (HD)



258.47

OX - 30 (HD)



258.47

OX - 40 (HD)



214.09

**Available in paint finishes only*

OX - 50 (HD)



214.09

Paint Only

OX - 60 (HD)



214.09

Paint Only

DS - PS (HD)



173.76

Paint Only

FB - PS (HD)



149.14

Paint Only

HP - PS (HD)



173.76

Paint Only

X - 52 (HD)



122.66

Add \$38.50 for Chrome

X - 53 (HD)



135.33

Add \$38.50 for Chrome
*limited supply

X - 55 (HD)



128.30

Add \$38.50 for Chrome

46 (HD)



87.80

49 NS(HD)



89.09

49 NSRB (HD)



173.40

Add \$24.17 for "V"

X - 50 / X - 51 (HD)



65.91

Paint Only

125 (HD)



82.19

125 RB (HD)



166.01

Add \$24.17 for "V"

781 (HD)



87.80

782 (HD)



89.09

782 RB (HD)



173.40

Add \$24.17 for "V"

782 RBMB (HD)



197.58

921 (HD)



138.48

Add \$24.17 for "V"

939 CBWF (HD)



185.73

Cantilevered Counter Stools

* Available with all head styles. Call for pricing.

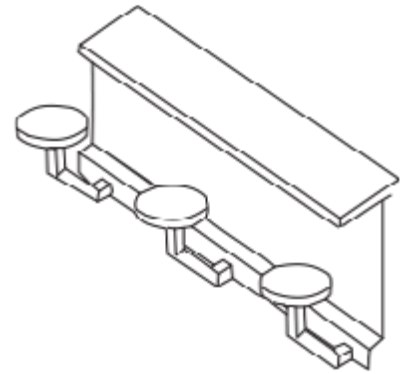

Up to Grade 3

Up to Grade 5

Head Style	Painted Cantilever with Painted Head	Chrome Cantilever with Chrome Head
FB - PS (HD)	479.52	N/A
DS - PS (HD)	479.52	N/A
HP - PS (HD)	479.52	N/A
X - 23 (HD)	387.56	494.97
X - 51 (HD)	434.34	N/A
X - 52 (HD)	434.34	554.69
X - 53 (HD)	434.34	554.69
X - 55 (HD)	434.34	554.69
46 (HD)	315.51	405.65
125 R (HD)	315.51	405.65
125 RB (HD)	424.93	515.06
242 (HD)	428.60	518.73
531 (HD)	424.93	515.06
781 (HD)	315.50	405.65
782 (HD)	315.50	405.65
782 RB (HD)	424.93	515.06
921 (HD)	424.93	515.06
921"V"(HD)	441.56	531.69
939 CB (HD)	428.60	518.73

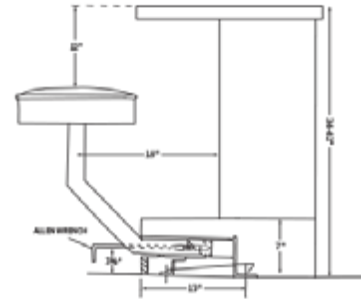

We do not construct the counter.

Counter construction by others must coordinate with the specifications illustrated.

Wood or concrete floor mount hardware, installation allen wrench, and installation details accompany your order at no charge. Installation details may also be obtained upon request prior to your order for planning purposes and we encourage you call CA

Cantilevered Counter Stools

Available with single shoes only
(the shoe is the lower portion)

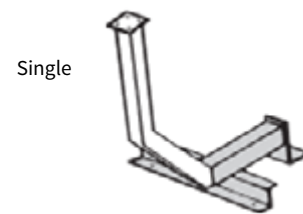

Modular Seating Plan

** Not built to scale*

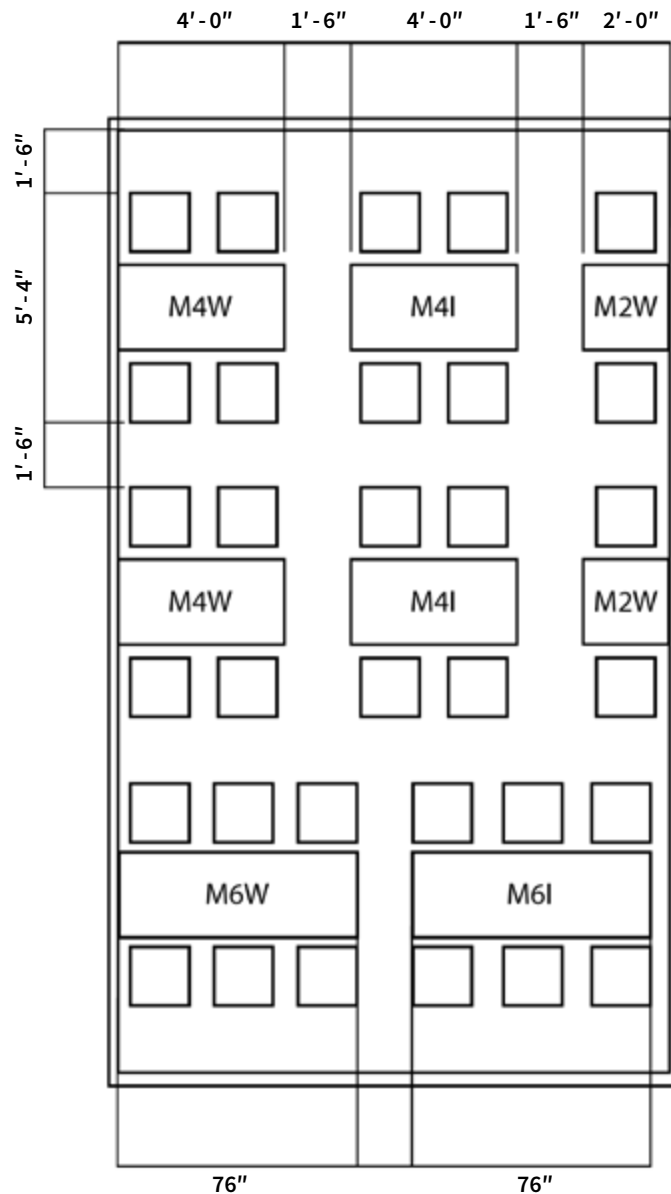

Note:

It is the responsibility of the owner or contractor to verify all building code requirements for total occupancy, Exiting and accessibility, Federal, State, City, and Municipal.

Note:

It is the owner's responsibility to verify all dimensions prior to order and fabrication



BOOTHS



Call (478) 320-2502 for Custom Sizes & Shapes



Single Booth

Seats 2 people side by side, generally 24" deep x 44" long. 48" length is also popular.



Double Booth

Seats 4 people (2 people side by side, as well as back to back), generally 45" deep x 44" long. 48" length is also popular.

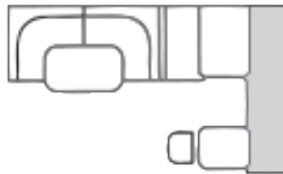

Wallbench

Constructed in virtually any length with sections normally restricted to 8ft. Attention should be given to location of the seams for aesthetic reasons, as well as comfort to the user.

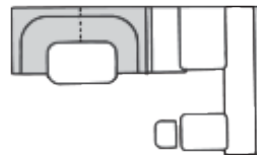

1/2 Circle Booth

Generally constructed in (2) 1/4 circle pieces with standard dimensions of 44" x 84" x 44". The outside back is always unfinished unless otherwise specified for aesthetic reasons, such as exposure due to windows, or perhaps no walls to cover the back.

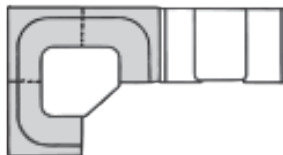

3/4 Circle Booth

Generally constructed in (3) 1/4 circle pieces with standard dimensions of 44" x 84" x 84" x 44". Again, the outside back remains unfinished unless otherwise specified.

Booth Options

Please Indicate the Booth number followed by the option number,
for example : **OZ - 2, SR - 3, LH - 4, etc.**

(Option Code - 2)	Laminate top & end panels.....	<i>Add \$80.81</i>
(Option Code - 3)	Wood top cap & end panels.....	<i>Add \$96.95</i>
(Option Code - 4)	42" height utilizing horizontal headrest....	<i>Add 25%</i>
(Option Code - 5)	42" height.....	<i>Add 15%</i>
(Option Code - 6)	Wood top cap & full end panels.....	<i>Add \$161.63</i>
(Option Code - 7)	48" Height.....	<i>Add 35%</i>
(Option Code - 8)	Laminate top cap.....	<i>Add \$36.67</i>
(Option Code - LSB)	Laminate sub base.....	<i>Add \$80.81</i>
(Option Code - LCS)	Laminate crumb strip.....	<i>Add \$38.79 single/\$77.56 double</i>
(Option Code - UCS)	Upholstered crumb strip.....	<i>Add \$32.32 single/\$64.64 double</i>
(Option Code - WTC)	Wood top cap.....	<i>Add \$48.48</i>
(Option Code - WSB)	Wood sub base.....	<i>Add \$161.63 single/\$211.46 double</i>
(Option Code - LOB)	Laminate outside back.....	<i>Add \$211.46</i>
(Option Code - LB)	Laminate base.....	<i>Add \$96.95</i>
	* Special Stain.....	<i>Add \$350.00 per job</i>

30" length or less.....	<i>Deduct 10%</i>
48" length.....	<i>Add 5%</i>
60" length.....	<i>Add 30%</i>

Note: Add \$258.54 for each 90° corner when using wallbench pricing

Note: Add \$969.80 for each mitered corner when using wallbench pricing



The Gateway Series in standard form (Model GY - 1)

represents a fully upholstered booth featuring a simple economical, smooth inside back and 36" overall height with no top cap.

	Grade 1	Grade 2	Grade 3	Grade 4	Grade 5	Weight	Dimensions
Single	482.00	498.86	516.33	534.40	553.10	110 lbs	24"D x 44"W
Double	723.00	748.30	774.49	801.59	829.65	150 lbs	45"D x 44"W
Wallbench per ft.	186.08	192.59	199.32	206.31	213.52	35 lbs	N/A
¼ Circle	1,747.14	1,799.24	1,853.17	1,908.97	1,966.75	210 lbs	44" x 44"
½ Circle	3,308.22	3,405.90	3,507.01	3,611.65	3,719.96	410 lbs	44" x 84" x 44"
¾ Circle	4,869.28	5,012.56	5,160.85	5,314.33	5,473.18	575 lbs	44" x 84" x 84" x 44"
OSB per ft.	32.24	33.37	34.54	35.75	37.00	N/A	N/A



The Ozark Series in standard form (Model OZ - 1)

represents a fully upholstered booth featuring a smooth inside back and 36" overall height.

* "V" option add \$155.29 (Single), \$310.57 (Double)

	Grade 1	Grade 2	Grade 3	Grade 4	Grade 5	Weight	Dimensions
Single	547.88	567.05	586.89	607.44	628.69	110 lbs	24"D x 44"W
Double	821.81	850.58	880.34	911.15	943.04	150 lbs	45"D x 44"W
Wallbench per ft.	186.98	193.52	200.29	207.31	214.56	35 lbs	N/A
¼ Circle	1,754.38	1,806.73	1,860.91	1,917.00	1,975.04	210 lbs	44" x 44"
½ Circle	3,321.78	3,419.94	3,521.54	3,626.69	3,735.52	410 lbs	44" x 84" x 44"
¾ Circle	4,889.18	5,033.15	5,182.17	5,336.39	5,496.02	575 lbs	44" x 84" x 84" x 44"
OSB per ft.	32.24	33.37	34.54	35.75	37.00	N/A	N/A

See Page 112 For All Available Options



Sierra

The Sierra Series in standard form (Model SR - 1)

represents a fully upholstered booth featuring 3 smooth panels separated by welt cord on the inside back and 36" overall height.

** Shown with optional two color upholstery*

	Grade 1	Grade 2	Grade 3	Grade 4	Grade 5	Weight	Dimensions
Single	574.30	594.40	615.20	636.74	659.02	110 lbs	24"D x 44"W
Double	861.44	891.59	922.80	955.10	988.53	150 lbs	45"D x 44"W
Wallbench per ft.	193.48	200.26	207.26	214.51	222.02	35 lbs	N/A
¼ Circle	1,806.40	1,860.57	1,916.64	1,974.68	2,034.74	210 lbs	44" x 44"
½ Circle	3,419.32	3,520.89	3,626.02	3,734.83	3,847.45	410 lbs	44" x 84" x 44"
¾ Circle	5,032.24	5,181.21	5,335.40	5,495.00	5,660.16	575 lbs	44" x 84" x 84" x 44"
OSB per ft.	32.24	33.37	34.54	35.75	37.00	N/A	N/A



Horizon

The Horizon Series in standard form (Model HZ - 1)

represents a solid wood trim top cap end panel and sub-base end panel with radiused edges, laminated crumb tray & sub-base are all standard, 35½" O.A. height.

** Add \$258.57 for each 90° corner when using wallbench pricing*

** Finished one end only*

	Grade 1	Grade 2	Grade 3	Grade 4	Grade 5	Weight	Dimensions
Single	919.34	951.51	984.81	1,019.28	1,054.96	185 lbs	24"D x 44"W
Double	1,378.99	1,427.26	1,477.21	1,528.92	1,582.43	240 lbs	46"D x 44"W
Wallbench per ft.	289.94	300.08	310.59	321.45	332.71	46 lbs	N/A
¼ Circle	2,578.06	2,659.24	2,743.27	2,830.22	2,920.24	350 lbs	44" x 44"
½ Circle	4,866.18	5,018.40	5,175.94	5,338.99	5,507.77	690 lbs	44" x 84" x 44"
¾ Circle	7,154.30	7,377.56	7,608.61	7,847.76	8,095.29	1012 lbs	44" x 84" x 84" x 44"
OSB per ft.	38.68	41.36	44.04	46.73	49.41	N/A	N/A

** Finished 2 sides add \$76.09 to above single & double prices*

** Standard wood trim is one side finished only*



Lockhaven

The Lockhaven Series in standard form (Model LH - 1)

represents a fully upholstered booth featuring vertical channel tufting on 7" centers and 36" overall height.

**Shown with optional wood top cap and three color upholstery*

**Shown with optional accent piping*

	Grade 1	Grade 2	Grade 3	Grade 4	Grade 5	Weight	Dimensions
Single	694.00	718.29	743.44	769.45	796.39	110 lbs	24"D x 44"W
Double	1,041.01	1,077.44	1,115.15	1,154.18	1,194.58	150 lbs	45"D x 44"W
Wallbench per ft.	209.90	217.25	224.85	232.73	240.87	35 lbs	N/A
¼ Circle	1,937.80	1,996.58	2,057.41	2,120.37	2,185.54	210 lbs	44" x 44"
½ Circle	3,665.72	3,775.92	3,889.97	4,008.02	4,130.20	410 lbs	44" x 84" x 44"
¾ Circle	5,393.62	5,555.24	5,722.53	5,895.67	6,074.86	575 lbs	44" x 84" x 84" x 44"
OSB per ft.	32.24	33.37	34.54	35.75	37.00	N/A	N/A



Lockhaven Optional

The Lockhaven Series (Optional Model LH - 2 - LSB)

represents a fully upholstered booth featuring vertical channel tufting on 7" centers and 36" overall height, with laminated top cap, end panels and sub base.

	Grade 1	Grade 2	Grade 3	Grade 4	Grade 5	Weight	Dimensions
Single	855.62	879.92	905.06	931.08	958.01	110 lbs	24"D x 44"W
Double	1,202.63	1,239.06	1,276.77	1,315.81	1,356.20	150 lbs	45"D x 44"W
Wallbench per ft.	255.96	263.31	270.91	278.77	286.92	35 lbs	N/A
¼ Circle	2,306.24	2,365.01	2,425.84	2,488.79	2,553.96	210 lbs	44" x 44"
½ Circle	4,356.52	4,466.72	4,580.77	4,698.82	4,821.00	410 lbs	44" x 84" x 44"
¾ Circle	6,406.80	6,568.42	6,735.70	6,908.84	7,088.04	575 lbs	44" x 84" x 84" x 44"
OSB per ft.	32.24	33.37	34.54	35.75	37.00	N/A	N/A



The Serenade Series in standard form (Model SD - 1)

represents a fully upholstered booth featuring diamond tufting and 36" overall height.

	Grade 1	Grade 2	Grade 3	Grade 4	Grade 5	Weight	Dimensions
Single	733.70	759.39	785.96	813.46	841.94	110 lbs	24"D x 44"W
Double	1,100.55	1,139.07	1,178.94	1,220.20	1,262.91	150 lbs	45"D x 44"W
Wallbench per ft.	236.94	245.23	253.81	262.70	271.90	35 lbs	N/A
¼ Circle	2,154.10	2,220.44	2,289.10	2,360.17	2,433.73	210 lbs	44" x 44"
½ Circle	4,071.24	4,195.64	4,324.39	4,457.64	4,595.56	410 lbs	44" x 84" x 44"
¾ Circle	5,988.40	6,170.85	6,359.67	6,555.11	6,757.39	575 lbs	44" x 84" x 84" x 44"
OSB per ft.	32.24	33.37	34.54	35.75	37.00	N/A	N/A



The Serenade Series (Optional Model SD - 2)

represents a fully upholstered booth featuring diamond tufting and 36" overall height, with laminated top cap & end panels.

	Grade 1	Grade 2	Grade 3	Grade 4	Grade 5	Weight	Dimensions
Single	814.52	840.19	866.77	894.28	922.75	110 lbs	24"D x 44"W
Double	1,181.37	1,219.88	1,259.75	1,301.01	1,343.72	150 lbs	45"D x 44"W
Wallbench per ft.	259.96	268.26	276.85	285.73	294.92	35 lbs	N/A
¼ Circle	2,338.30	2,404.66	2,473.32	2,544.39	2,617.93	210 lbs	44" x 44"
½ Circle	4,416.64	4,541.04	4,669.79	4,803.04	4,940.96	410 lbs	44" x 84" x 44"
¾ Circle	6,494.98	6,677.43	6,866.26	7,061.70	7,263.98	575 lbs	44" x 84" x 84" x 44"
OSB per ft.	32.24	33.37	34.54	35.75	37.00	N/A	N/A



The Gravois Series in standard form (Model GV - 1)

represents a fully upholstered booth featuring a horizontal head roll atop a smooth, lower inside back and 36" overall height.

** Shown with three color upholstery*

	Grade 1	Grade 2	Grade 3	Grade 4	Grade 5	Weight	Dimensions
Single	705.50	730.18	755.74	782.19	809.57	110 lbs	24"D x 44"W
Double	1,058.23	1,095.27	1,133.61	1,173.28	1,214.36	150 lbs	45"D x 44"W
Wallbench per ft.	206.94	214.19	221.68	229.45	237.48	35 lbs	N/A
¼ Circle	1,914.14	1,972.09	2,032.06	2,094.14	2,158.39	210 lbs	44" x 44"
½ Circle	3,621.34	3,729.99	3,842.44	3,958.83	4,079.28	410 lbs	44" x 84" x 44"
¾ Circle	5,328.54	5,487.90	5,652.82	5,823.52	6,000.19	575 lbs	44" x 84" x 84" x 44"
OSB per ft.	32.24	33.37	34.54	35.75	37.00	N/A	N/A



The Gravois Series (Optional Model GV - 3)

represents a fully upholstered booth featuring a horizontal head roll atop a smooth, lower inside back and 36" overall height, with wood top cap & end panels.

	Grade 1	Grade 2	Grade 3	Grade 4	Grade 5	Weight	Dimensions
Single	802.46	827.16	852.71	879.16	906.54	110 lbs	24"D x 44"W
Double	1,155.21	1,192.25	1,230.58	1,270.26	1,311.32	150 lbs	45"D x 44"W
Wallbench per ft.	234.64	241.89	249.38	257.14	265.18	35 lbs	N/A
¼ Circle	2,135.72	2,193.65	2,253.63	2,315.70	2,379.95	210 lbs	44" x 44"
½ Circle	4,036.78	4,145.43	4,257.88	4,374.26	4,494.72	410 lbs	44" x 84" x 44"
¾ Circle	5,937.84	6,097.20	6,262.12	6,432.82	6,609.49	575 lbs	44" x 84" x 84" x 44"
OSB per ft.	32.24	33.37	34.54	35.75	37.00	N/A	N/A

See Page 112 For All Available Options



Fenton

The Fenton Series in standard form (**Model FN - 1**)

represents a fully upholstered booth featuring 3 horizontal channels and 36" overall height.

**Shown with optional two color upholstery*

	Grade 1	Grade 2	Grade 3	Grade 4	Grade 5	Weight	Dimensions
Single	820.48	849.20	878.91	909.68	941.51	110 lbs	24"D x 44"W
Double	1,230.71	1,273.79	1,318.37	1,364.52	1,412.28	150 lbs	45"D x 44"W
Wallbench per ft.	240.94	249.38	258.12	267.15	276.50	35 lbs	N/A
¼ Circle	2,186.16	2,253.63	2,323.45	2,395.72	2,470.52	210 lbs	44" x 44"
½ Circle	4,131.38	4,257.88	4,388.80	4,524.31	4,664.56	410 lbs	44" x 84" x 44"
¾ Circle	6,076.60	6,262.12	6,454.15	6,652.90	6,858.60	575 lbs	44" x 84" x 84" x 44"
OSB per ft.	32.24	33.37	34.54	35.75	37.00	N/A	N/A



Fenton Optional

The Fenton Series (Optional Model FN - 4 - WTC)

represents a fully upholstered booth featuring 3 horizontal channels and 42" overall height utilizing a horizontal headrest with wood top cap.

	Grade 1	Grade 2	Grade 3	Grade 4	Grade 5	Weight	Dimensions
Single	1,074.44	1,110.33	1,147.49	1,185.94	1,225.74	110 lbs	24"D x 44"W
Double	1,587.23	1,641.08	1,696.81	1,754.49	1,814.19	150 lbs	45"D x 44"W
Wallbench per ft.	315.10	325.63	336.55	347.84	359.52	35 lbs	N/A
¼ Circle	2,779.34	2,863.66	2,950.95	3,041.29	3,314.79	210 lbs	44" x 44"
½ Circle	5,243.57	5,401.69	5,565.35	5,734.74	5,910.05	410 lbs	44" x 84" x 44"
¾ Circle	7,707.81	7,939.72	8,179.75	8,428.19	8,685.31	575 lbs	44" x 84" x 84" x 44"
OSB per ft.	40.28	41.69	43.15	44.66	46.22	N/A	N/A

See Page 112 For All Available Options



Streamliner

The **Streamliner Series** in standard form (**Model ST - 4300**) represents a fully upholstered booth featuring double twin outer channel back with a classic high base design. This attractive booth is offered in two colors upholstery at no extra charge. Standard 36" height.

	Grade 1	Grade 2	Grade 3	Grade 4	Grade 5	Weight	Dimensions
Single	712.56	737.50	763.31	790.02	817.67	110 lbs	24"D x 44"W
Double	1,068.84	1,106.25	1,144.96	1,185.03	1,226.51	150 lbs	45"D x 44"W
Wallbench per ft.	235.80	244.05	252.58	261.43	270.58	35 lbs	N/A
¼ Circle	2,144.90	2,210.92	2,279.26	2,349.99	2,423.18	210 lbs	44" x 44"
½ Circle	4,054.02	4,177.80	4,305.93	4,438.53	4,575.78	410 lbs	44" x 84" x 44"
¾ Circle	5,963.12	6,144.69	6,332.60	6,527.09	6,728.38	575 lbs	44" x 84" x 84" x 44"
OSB per ft.	32.24	33.37	34.54	35.75	37.00	N/A	N/A



Odyssey

The **Odyssey Series** in standard form (**Model OD - 6000**) represents a unique, thin line style from the past. Frame is available in painted finishes.

* Shown with optional accent piping & buttons

* Button upcharge add \$49.00 (Single), \$98.00 (Double)



Single

	Grade 1	Grade 2	Grade 3	Grade 4	Grade 5	Weight	Dimensions
Single	681.70	705.56	730.26	755.82	782.28	85 lbs	24"D x 44"W
Double	1,022.56	1,058.35	1,095.39	1,133.73	1,173.41	110 lbs	45"D x 44"W
Wallbench per ft.	198.96	205.92	213.13	220.58	228.31	25 lbs	N/A
OSB per ft.	32.24	33.37	34.54	35.75	37.00	N/A	N/A

*30" length or less deduct 10%

*48" length add 5%

*60" length add 30%



The Norwood Series (Model NW - 5 - CT - UCS)

represents a fully upholstered booth featuring a custom gallery (CT), and a 42" overall height with wood top cap & end panels.

** Standard wood trim is finished on one side only*

** Finished 2 sides add \$76.09 to single & double prices*

	Grade 1	Grade 2	Grade 3	Grade 4	Grade 5	Weight	Dimensions
Single	1,331.11	1,377.70	1,425.92	1,475.83	1,527.48	110 lbs	24"D x 44"W
Double	1,996.67	2,066.55	2,138.88	2,213.74	2,291.22	150 lbs	45"D x 44"W



The Norwood Series (Optional Model NW - 5 - UCS - WSB)

represents a fully upholstered smooth back booth featuring a 42" overall height with wood top cap, sub-base, and end panels.

** Standard wood trim is finished on one side only*

** Finished 2 sides add \$76.09 to single & double prices*

	Grade 1	Grade 2	Grade 3	Grade 4	Grade 5	Weight	Dimensions
Single	1,255.56	1,299.50	1,344.98	1,392.06	1,440.78	110 lbs	24"D x 44"W
Double	1,883.33	1,949.25	2,017.47	2,088.09	2,161.17	150 lbs	45"D x 44"W



Bel - Air

The Bel - Air Series in standard form (Model BA - 4300)

represents a fully upholstered booth featuring a smooth inside back with a classic high base design. Standard 36" height.

	Grade 1	Grade 2	Grade 3	Grade 4	Grade 5	Weight	Dimensions
Single	532.96	551.62	570.92	590.91	611.59	110 lbs	24"D x 44"W
Double	799.45	827.42	856.38	886.36	917.38	150 lbs	45"D x 44"W
Wallbench per ft.	200.50	207.52	214.78	222.29	230.08	35 lbs	N/A
¼ Circle	1,862.52	1,918.65	1,976.77	2,036.90	2,099.14	210 lbs	44" x 44"
½ Circle	3,524.54	3,629.80	3,738.75	3,851.51	3,968.21	410 lbs	44" x 84" x 44"
¾ Circle	5,186.58	5,340.95	5,500.74	5,666.11	5,837.27	575 lbs	44" x 84" x 84" x 44"
OSB per ft.	32.24	33.37	34.54	35.75	37.00	N/A	N/A



Vintage

The Vintage Series (Model V - 4300)

represents a fully upholstered booth of classic design. "V" back with choice of the high enclosed base (standard) or the optional high pedestal design. No charge for contrasting "V" and welt in same grade. Standard 36" height.

*(PED) - Pedestal base - Add \$64.64 (Single), \$96.94 (Double)



	Grade 1	Grade 2	Grade 3	Grade 4	Grade 5	Weight	Dimensions
Single	678.66	702.41	726.99	752.43	778.77	110 lbs	24"D x 44"W
Double	1,017.97	1,053.60	1,090.49	1,128.64	1,168.16	150 lbs	45"D x 44"W
Wallbench per ft.	224.58	232.43	240.57	248.99	257.70	35 lbs	N/A
¼ Circle	2,055.14	2,118.02	2,183.10	2,250.46	2,320.18	210 lbs	44" x 44"
½ Circle	3,885.72	4,003.62	4,125.64	4,251.94	4,382.65	410 lbs	44" x 84" x 44"
¾ Circle	5,716.28	5,889.20	6,068.17	6,253.41	6,445.13	575 lbs	44" x 84" x 84" x 44"
OSB per ft.	32.24	33.37	34.54	35.75	37.00	N/A	N/A

See Page 112 For All Available Options



Hollywood

The Hollywood Series in standard form (**Model HW - 4300**)

represents a fully upholstered booth featuring vertical channel tufting on 7" centers. High enclosed base is standard or choose the optional high pedestal design. Standard 36" height.

**(PED) - Pedestal base - Add \$64.64 (Single), \$96.94 (Double)*

	Grade 1	Grade 2	Grade 3	Grade 4	Grade 5	Weight	Dimensions
Single	712.56	737.50	763.31	790.02	817.67	110 lbs	24"D x 44"W
Double	1,068.84	1,106.25	1,144.96	1,185.03	1,226.51	150 lbs	45"D x 44"W
Wallbench per ft.	235.80	244.05	252.58	261.43	270.58	35 lbs	N/A
¼ Circle	2,144.90	2,210.92	2,279.26	2,349.99	2,423.18	210 lbs	44" x 44"
½ Circle	4,054.02	4,177.80	4,305.93	4,438.53	4,575.78	410 lbs	44" x 84" x 44"
¾ Circle	5,963.12	6,144.69	6,332.60	6,527.09	6,728.38	575 lbs	44" x 84" x 84" x 44"
OSB per ft.	32.24	33.37	34.54	35.75	37.00	N/A	N/A



Chevie

The Chevie Series in standard form (**Model CH - 1**)

represents a fully upholstered booth featuring a "V" shape head roll with 11 vertical channels at 4" centers. This attractive booth is offered in two colors of upholstery in same grade at no extra charge. Standard 36" height.

** Shown with optional accent piping*

	Grade 1	Grade 2	Grade 3	Grade 4	Grade 5	Weight	Dimensions
Single	940.08	972.98	1,007.04	1,042.28	1,078.77	110 lbs	24"D x 44"W
Double	1,410.12	1,459.48	1,510.56	1,563.43	1,618.16	150 lbs	45"D x 44"W
Wallbench per ft.	276.50	286.17	296.19	306.55	317.28	35 lbs	N/A
¼ Circle	2,470.50	2,547.92	2,628.04	2,710.98	2,796.82	210 lbs	44" x 44"
½ Circle	4,664.52	4,809.67	4,959.91	5,115.41	5,276.35	410 lbs	44" x 84" x 44"
¾ Circle	6,858.52	7,071.43	7,291.77	7,519.83	7,755.88	575 lbs	44" x 84" x 84" x 44"
OSB per ft.	32.24	33.37	34.54	35.75	37.00	N/A	N/A

See Page 112 For All Available Options



Elite

The Elite Series in standard form (**Model EL - 4300**)

represents a fully upholstered booth of classic design. "Elite" back with the choice of the high enclosed base (standard) or the optional high pedestal design. No charge for contrasting "Elite - V" and welt in same grade. Standard 36" height.

* Shown with optional acrylic gallery (See pg. 159)

	Grade 1	Grade 2	Grade 3	Grade 4	Grade 5	Weight	Dimensions
Single	678.66	702.41	726.99	752.43	778.77	110 lbs	24"D x 44"W
Double	1,017.97	1,053.60	1,090.49	1,128.64	1,168.16	150 lbs	45"D x 44"W
Wallbench per ft.	224.58	232.43	240.57	248.99	257.70	35 lbs	n/a
¼ Circle	2,055.14	2,118.02	2,183.10	2,250.46	2,320.18	210 lbs	44" x 44"
½ Circle	3,885.72	4,003.62	4,125.64	4,251.94	4,382.65	410 lbs	44" x 84" x 44"
¾ Circle	5,716.28	5,889.20	6,068.17	6,253.41	6,445.13	575 lbs	44" x 84" x 84" x 44"
OSB per ft.	32.24	33.37	34.54	35.75	37.00	n/a	n/a



Malibu

The Malibu Series (Model MB - 4300)

represents a fully upholstered booth of classic design featuring a roll and pleat tufted back insert. Standard 36" height.

* Refer to Seaquest card for available tufted colors

*(PED) - Pedestal base - Add \$64.64 (Single), \$96.94 (Double)

* Shown with optional accent piping



	Grade 1	Grade 2	Grade 3	Grade 4	Grade 5	Weight	Dimensions
Single	712.56	737.50	763.31	790.02	817.67	110 lbs	24"D x 44"W
Double	1,068.84	1,106.25	1,144.96	1,185.03	1,226.51	150 lbs	45"D x 44"W
Wallbench per ft.	235.80	244.05	252.58	261.43	270.58	35 lbs	N/A
¼ Circle	2,144.90	2,210.92	2,279.26	2,349.99	2,423.18	210 lbs	44" x 44"
½ Circle	4,054.02	4,177.80	4,305.93	4,438.53	4,575.78	410 lbs	44" x 84" x 44"
¾ Circle	5,963.12	6,144.69	6,332.60	6,527.09	6,728.38	575 lbs	44" x 84" x 84" x 44"
OSB per ft.	32.24	33.37	34.54	35.75	37.00	N/A	N/A

Midway Booths Have No Available Options



Midway Smooth

The Midway Series in standard form (Model MD - 1000)

represents a fully upholstered booth featuring 36" height and five selected colors to choose from; beige, saddle, black, dark green, and cranberry; No top cap.

**5 colors to choose from. (See below)*

	Price	Weight	Dimensions
Single	498.33	110 lbs	24"D x 44"W
Double	753.88	150 lbs	45"D x 44"W



Midway 3 panel

The Midway Series in standard form (Model MD - 3000)

with the 3 panel option. No top cap.

**5 colors to choose from.*



Beige Black Cranberry Dark Green Saddle

	Price	Weight	Dimensions
Single	528.88	110 lbs	24"D x 44"W
Double	816.99	150 lbs	45"D x 44"W



Midway 4 panel

The Midway Series in standard form (Model MD - 4000)

with the 4 panel option. No top cap.

**5 colors to choose from.*



Beige Black Cranberry Dark Green Saddle

	Price	Weight	Dimensions
Single	587.77	110 lbs	24"D x 44"W
Double	881.67	150 lbs	45"D x 44"W



Settee

The Smooth Settee in standard form (Model S-ST)

represents the smooth top, backless waiting settee.

Optional contrasting welt available upon request.

** Only available as a bench*

** Shown with optional accent piping*

	Grade 1	Grade 2	Grade 3	Grade 4	Grade 5	Weight	Dimensions
Bench per ft.	152.48	157.82	163.35	169.06	174.98	24 lbs	18"H x 20"D

**per foot*



Tufted Settee

The Tufted Settee (Model S-TT)

represents an optional version offering tufted upholstery.

** Only available as a bench*

** Shown with optional contrasting welt*

	Grade 1	Grade 2	Grade 3	Grade 4	Grade 5	Weight	Dimensions
Bench per ft.	156.68	162.17	167.85	173.72	179.81	24 lbs	18"H x 20"D

**per foot*

Settee Series is sold per foot

BOOTH SEATING

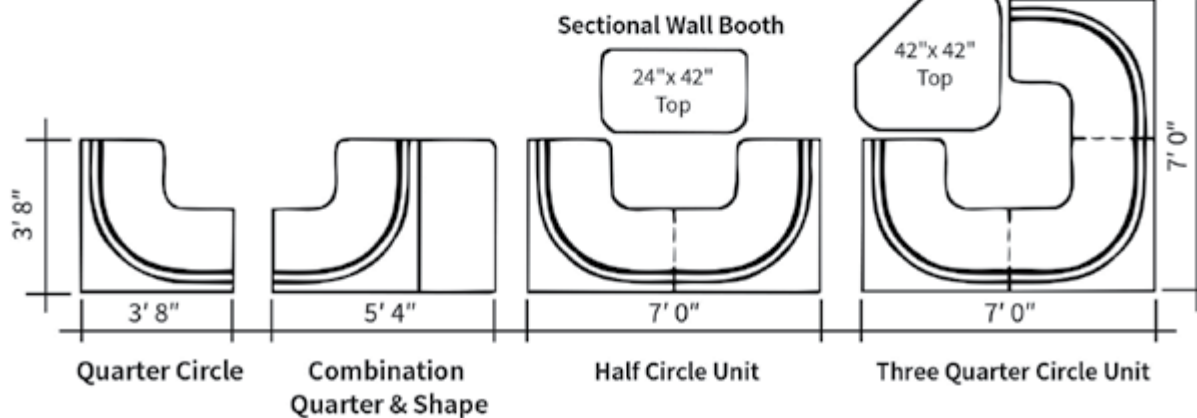
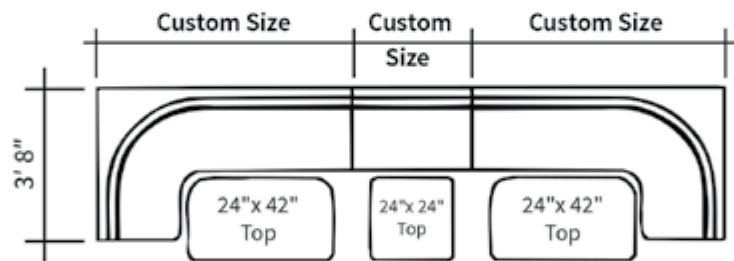
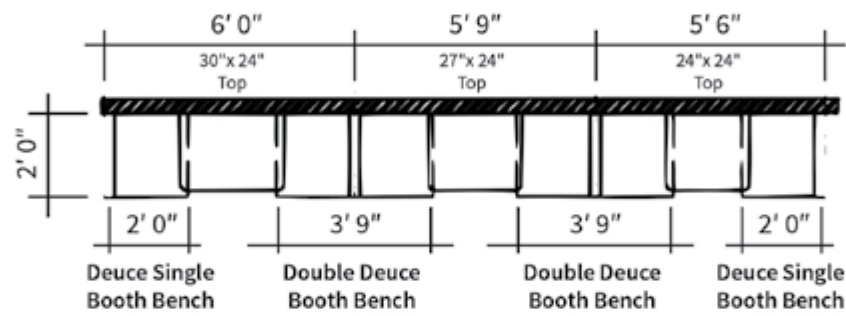
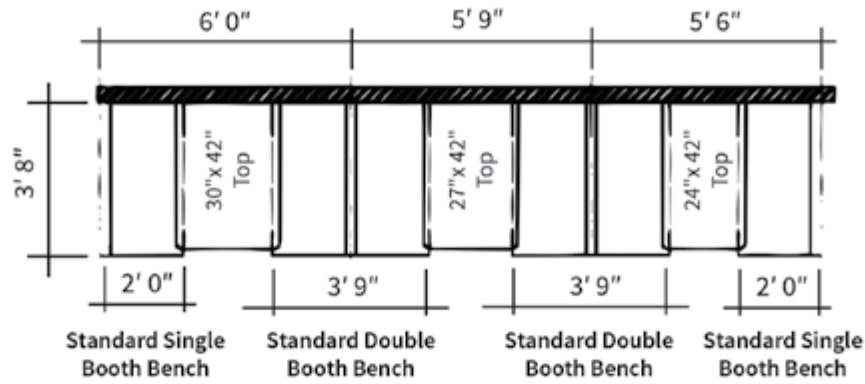



TABLES & BASES

NewRetroDining.com

Made in USA - Retro 50's Furniture

Table Tops



**Ebony boomerang laminate*

Round Table

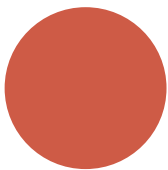

Most common

Oval



Racetrack oval

Wall Positioned



Table fits flush against the wall for single and double booth seating

42" x 42" CT



Used for ¾ circle booth

½ CT



Used for ½ circle booth

⅓ CT



Used for ¼ circle booth

Custom sizes are available upon request

Order both tables & pedestal bases together and we will pre-drill tables to accommodate those bases at no charge unless stated otherwise.

Bumper Edge



BE - 125

* Backing sheet add 10%

Edge Colors

Red
Green
Brown
Beige
Burgundy
Almond
Sand
Teal
Blue
Gray
Graphite
Black
White
Natural woodgrain
Walnut woodgrain

BE - 125 Table Top, 1¼" x ¼" Thick Bumper Edge, laminates available in standard Wilsonart & Formica.

	1 - 4	5 - 30	31+	Lbs.
24" x 24"	110.00	85.56	81.49	30
24" x 22"WP	110.00	85.56	81.49	30
24" x 24"CT	124.88	100.44	95.67	30
24" x 30"	129.04	104.60	99.63	35
24" x 28"WP	129.04	104.60	99.63	35
30" x 22"WP	129.04	104.60	99.63	35
24" x 42"	160.18	135.74	129.29	40
24" x 42"WP	160.18	135.74	129.29	40
24" x 42"CT	175.04	150.60	143.45	40
24" x 46"WP	167.98	143.54	136.72	45
24" x 48"	167.98	143.54	136.72	45
24" x 48"WP	167.98	143.54	136.72	45
30" x 30"	136.84	112.40	107.05	35
30" x 28"WP	136.84	112.40	107.05	40
30" x 42"	167.98	143.54	136.72	55
30" x 42"WP	167.98	143.54	136.72	55
30" x 46"WP	198.20	173.76	165.50	60
30" x 48"	198.20	173.76	165.50	60
30" x 58"WP	282.12	257.66	245.43	80
30" x 60"	282.12	257.66	245.43	80
30" x 72"	341.10	316.66	301.61	105
36" x 36"	177.98	153.54	146.25	55
42" x 42"	291.64	267.20	254.51	80
42" x 42"CT	313.92	289.48	275.73	80
48" x 48"	323.72	296.59	282.51	95
24" Round	121.24	96.80	92.20	25
30" Round	154.12	129.68	123.52	30
36" Round	191.32	166.88	158.95	45
42" Round	293.34	268.88	256.11	65
48" Round	323.62	299.18	284.97	80
54" Round	506.98	482.54	459.61	110
60" Round	544.10	519.66	494.98	140

Bullnose Bumper Edge



BN - 125

*Backing sheet add 10%

**Bullnose Bumper
Edge is available
in Black**

BN - 125 Table Top, 1¼" x ½" Bullnose Bumper Edge, laminates available in standard Wilsonart & Formica.

	1 - 4	5 - 30	31+	Lbs.
24" x 24"	127.14	102.70	97.81	30
24" x 22"WP	127.14	102.70	97.81	30
24" x 24"CT	142.00	117.56	111.97	30
24" x 30"	149.94	125.50	119.54	35
24" x 28"WP	149.94	125.50	119.54	35
30" x 22"WP	149.94	125.50	119.54	35
24" x 42"	187.36	162.92	155.19	40
24" x 42"WP	187.36	162.92	155.19	40
24" x 42"CT	202.18	177.74	169.29	40
24" x 46"WP	196.70	172.26	164.08	45
24" x 48"	196.70	172.26	164.08	45
24" x 48"WP	196.70	172.26	164.08	45
30" x 30"	159.32	134.88	128.48	35
30" x 28"WP	159.32	134.88	128.48	40
30" x 42"	196.70	172.26	164.08	55
30" x 42"WP	196.70	172.26	164.08	55
30" x 46"WP	233.02	208.58	198.68	60
30" x 48"	233.02	208.58	198.68	60
30" x 58"WP	333.64	309.20	294.51	80
30" x 60"	333.64	309.20	294.51	80
30" x 72"	404.26	379.82	361.78	105
36" x 36"	200.84	176.40	168.01	55
42" x 42"	345.00	320.56	305.34	80
42" x 42"CT	367.36	342.90	326.62	80
48" x 48"	382.95	355.82	338.91	95
24" Round	140.62	116.18	110.67	25
30" Round	180.08	155.64	148.25	30
36" Round	224.72	200.28	190.76	45
42" Round	347.12	322.66	307.34	65
48" Round	383.44	359.00	341.94	80
54" Round	603.42	578.96	551.46	110
60" Round	648.00	623.56	593.93	140

Economy Wood Edge



Eased

EWE - 125

*Eased edge only

Economy Wood Edge Table Top, 1¼" Wood Edge with ⅝" reveal, laminate is flush with top of wood. Corners are eased, mitered. Laminates available in standard Wilsonart & Formica.

	1 - 6	7+	Lbs.
24" x 24"	243.94	221.76	30
24" x 30"	291.46	264.96	35
24" x 42"	338.98	308.16	40
24" x 48"	338.98	308.16	45
30" x 30"	357.18	324.71	35
30" x 42"	422.94	384.49	55
30" x 48"	422.94	384.49	60
30" x 60"	488.67	444.25	80
30" x 72"	554.40	504.00	105
36" x 36"	357.18	324.71	55
42" x 42"	506.88	460.80	80
42" x 42"CT	728.64	662.40	80
48" x 48"	506.88	460.80	95
24" Round	433.89	394.44	25
30" Round	578.94	526.31	30
36" Round	610.62	555.11	45
42" Round	760.32	691.20	65
48" Round	823.68	748.80	80
54" Round	1,009.80	918.00	110
60" Round	1,041.48	946.80	140

*These particular table tops cannot be pre-drilled for table bases

*Add \$29.33 list for 3" or 6" radius corners

Standard Wood Finishes



Walnut

Black

Cherry

Dark Mahogany

Mahogany

Natural

*Finishes are reproduced as accurately as possible, colors may vary from actual product color.

Deluxe Wood Edge



Rolled

DWR - 125

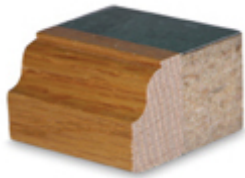

Waterfall

DWW - 125



Bullnose

DWB - 125

Deluxe Wood Edge Table Top, 1¼" Wood Edge with ⅝" reveal, laminate is flush with top of wood. Corners are eased, mitered. Laminates available in standard Wilsonart & Formica.

	1 - 6	7+	Lbs.
24" x 24"	262.95	239.04	30
24" x 30"	315.21	286.56	35
24" x 42"	367.50	334.09	40
24" x 48"	367.50	334.09	45
30" x 30"	385.71	350.64	35
30" x 42"	456.18	414.71	55
30" x 48"	456.18	414.71	60
30" x 60"	526.88	478.80	80
30" x 72"	597.18	542.89	105
36" x 36"	385.71	350.64	55
42" x 42"	544.90	495.36	80
42" x 42"CT	766.65	696.96	80
48" x 48"	544.90	495.36	95
24" Round	453.03	411.84	25
30" Round	607.47	552.24	30
36" Round	639.15	581.04	45
42" Round	798.33	725.76	65
48" Round	861.69	783.36	80
54" Round	1,057.32	961.20	110
60" Round	1,120.88	1,018.80	140

*These particular table tops cannot be pre-drilled for table bases

*Add \$29.33 list for 3" or 6" radius corners

Standard Wood Finishes

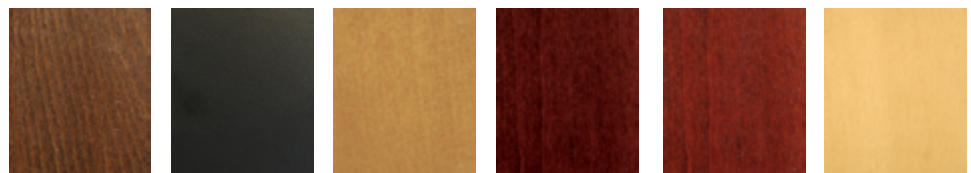

Walnut

Black

Cherry

Dark Mahogany

Mahogany

Natural

*Finishes are reproduced as accurately as possible, colors may vary from actual product color.

Premium Wood Edge



Eased

PWE - 125



Waterfall

PWW - 125

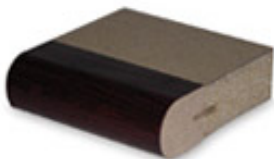

Bullnose

PWB - 125



Rolled

PWR - 125

Premium Wood Edge Table Top, 1¼" Wood Edge with 1¼" reveal, laminate edge is flush with top of wood. Layered lap joints (*Inlaid*). Corners are mitered. Laminates available in standard Wilsonart or Formica.

	1 - 6	7+	Lbs.
24" x 24"	281.94	256.31	30
24" x 30"	338.98	308.16	35
24" x 42"	396.00	360.00	40
24" x 48"	396.00	360.00	45
30" x 30"	414.22	376.56	35
30" x 42"	489.46	444.96	55
30" x 48"	489.46	444.96	60
30" x 60"	564.70	513.36	80
30" x 72"	639.94	581.76	105
36" x 36"	414.22	376.56	55
42" x 42"	582.90	529.91	80
42" x 42"CT	804.66	731.51	80
48" x 48"	582.90	529.91	95
24" Round	472.02	429.11	25
30" Round	635.98	578.16	30
36" Round	667.66	606.96	45
42" Round	836.34	760.31	65
48" Round	899.70	817.91	80
54" Round	1,104.84	1,004.40	110
60" Round	1,168.20	1,062.00	140

*These particular table tops cannot be pre-drilled for table bases

*Add \$29.33 list for 3" or 6" radius corners

Standard Wood Finishes

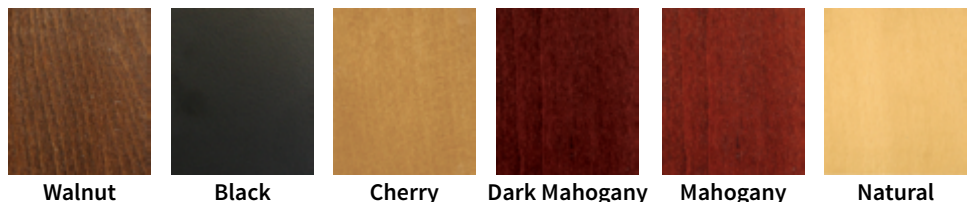

Walnut

Black

Cherry

Dark Mahogany

Mahogany

Natural

*Finishes are reproduced as accurately as possible, colors may vary from actual product color.

Ultimate Wood Edge



Eased

UWE - 175



Waterfall

UWW - 175



Bullnose

UWB - 175



Rolled

UWR - 175

Ultimate Wood Edge Table Top, 1¾" Wood Edge with 1¾" edge reveal, laminate is flush with top of wood. Corners mitered. Laminates available in standard Wilsonart & Formica.

	1 - 6	7+	Lbs.
24" x 24"	294.62	267.84	30
24" x 30"	354.82	322.56	35
24" x 42"	415.02	377.29	40
24" x 48"	415.02	377.29	45
30" x 30"	433.22	393.84	35
30" x 42"	511.62	465.11	55
30" x 48"	511.62	465.11	60
30" x 60"	590.04	536.40	80
30" x 72"	668.46	607.69	105
36" x 36"	433.22	393.84	55
42" x 42"	608.26	552.96	80
42" x 42"CT	830.02	754.56	80
48" x 48"	608.26	552.96	95
24" Round	484.70	440.64	25
30" Round	654.98	595.44	30
36" Round	686.66	624.24	45
42" Round	861.70	783.36	65
48" Round	925.06	840.96	80
54" Round	1,136.52	1,033.20	110
60" Round	1,199.88	1,090.80	140

*These particular table tops cannot be pre-drilled for table bases

*Add \$29.33 list for 3" or 6" radius corners

Standard Wood Finishes

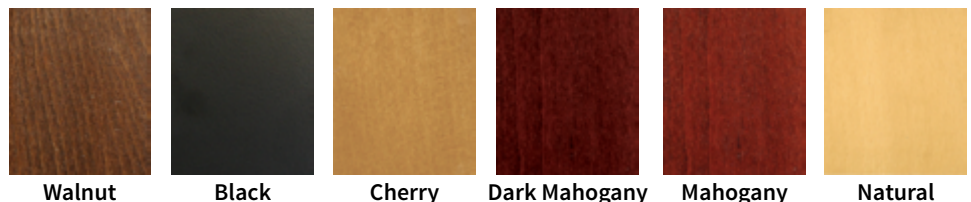

Walnut

Black

Cherry

Dark Mahogany

Mahogany

Natural

*Finishes are reproduced as accurately as possible, colors may vary from actual product color.

Solid Wood



Eased

SWE - 150



Bullnose

SWB - 150

Solid Wood Edge Table Top (SW - 150), 1½ Top thickness with continuous lengths of solid Beech or Hard Maple. Corners are standard ⅜" radius.

	1 - 6	7+	Lbs.
24" x 24"	410.65	400.20	30
24" x 24" CT	552.24	538.20	30
24" x 30"	481.44	469.20	34
24" x 42"	608.89	593.40	40
24" x 42" CT	750.49	731.40	40
24" x 48"	608.89	593.40	45
30" x 30"	509.76	496.80	42
30" x 42"	665.51	648.60	59
30" x 48"	665.51	648.60	67
30" x 60"	750.49	731.40	80
30" x 72"	877.91	855.60	101
36" x 36"	651.36	634.80	61
36" x 36"/51"	1,441.49	1,404.84	61
42" x 42"	877.91	855.60	121
42" x 42" CT	1,019.51	993.60	121
48" x 48"	962.89	938.40	80
24" Round	538.09	524.40	77
30" Round	594.71	579.60	34
36" Round	722.16	703.80	48
42" Round	821.29	800.40	70
48" Round	1,047.84	1,021.20	85

*These particular table tops cannot be pre-drilled for table bases

Standard Wood Finishes

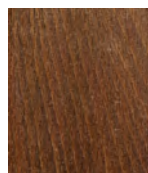

Walnut

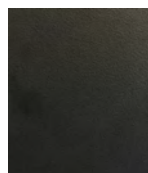

Black

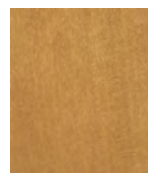

Cherry

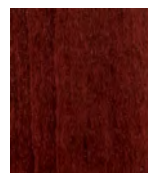

Dark Mahogany



Mahogany



Natural

*Finishes are reproduced as accurately as possible, colors may vary from actual product color.

BGA - 125 Table Top



BGA - 125

* Backing sheet add 10%

GA - 125 also available
in *satin edge*.

BGA - 125 Table Top, 1¼" Bright Grooved Aluminum Edge,
laminates available in standard Wilsonart & Formica.

	1 - 4	5 - 30	31+	Lbs.
24" x 24"	119.90	95.46	90.93	30
24" x 22"WP	122.28	97.82	93.18	30
24" x 24"CT	136.44	112.00	106.69	30
24" x 30"	143.98	119.54	113.86	35
24" x 28"WP	143.98	119.54	113.86	35
30" x 22"WP	143.98	119.54	113.86	35
24" x 42"	179.62	155.18	147.81	40
24" x 42"WP	179.62	155.18	147.81	40
24" x 42"CT	193.78	169.32	161.28	40
24" x 46"WP	188.50	164.04	156.26	45
24" x 48"	188.50	164.04	156.26	45
24" x 48"WP	188.50	164.04	156.26	45
30" x 30"	152.92	128.48	122.38	35
30" x 28"WP	152.92	128.48	122.38	40
30" x 42"	188.50	164.04	156.26	55
30" x 42"WP	188.50	164.04	156.26	55
30" x 46"WP	223.10	198.66	189.22	60
30" x 48"	223.10	198.66	189.22	60
30" x 58"WP	333.64	309.20	294.51	80
30" x 60"	333.64	309.20	294.51	80
30" x 72"	404.26	379.82	361.78	105
36" x 36"	192.45	168.00	160.03	55
42" x 42"	340.78	316.34	301.31	80
42" x 42"CT	351.04	326.60	311.09	80
48" x 48"	378.27	351.14	334.45	95
24" Round	135.12	110.68	105.42	25
30" Round	172.68	148.24	141.19	30
36" Round	215.18	190.74	181.68	45
42" Round	331.76	307.32	292.72	65
48" Round	366.34	341.90	325.67	80
54" Round	603.42	578.96	551.46	110
60" Round	648.00	623.56	593.93	140

	1 - 4	5 - 30
36" x 48" Oval	413.46	389.00
36" x 60" Oval	793.78	769.34

BGA-125 Gloss Cracked Ice



BGA-125 Cracked Ice

* Backing sheet add 10%

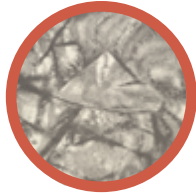

Grey

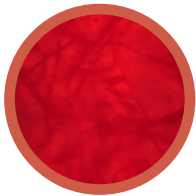

Red



Yellow

BGA-125 Table Top, 1¼" Bright Grooved Aluminum Edge.

Premium high-gloss Cracked Ice laminate.

	1-4	5-30	31+	Lbs.
24" x 24"	187.70	163.26	155.51	30
24" x 22"WP	187.70	163.26	155.51	30
24" x 24"CT	203.26	178.82	170.31	30
24" x 30"	225.48	201.04	191.48	35
24" x 28"WP	225.48	201.04	191.48	35
30" x 22"WP	225.48	201.04	191.48	35
24" x 42"	292.42	267.98	255.26	40
24" x 42"WP	292.42	267.98	255.26	40
24" x 42"CT	308.00	283.56	270.08	40
24" x 46"WP	316.06	291.62	277.77	45
24" x 48"	316.06	291.62	277.77	45
24" x 48"WP	316.06	291.62	277.77	45
30" x 30"	255.20	228.16	219.79	35
30" x 28"WP	255.20	228.16	219.79	40
30" x 42"	326.46	302.02	287.66	55
30" x 42"WP	326.46	302.02	287.66	55
30" x 46"WP	381.84	357.40	333.83	60
30" x 48"	381.84	357.40	333.83	60
30" x 58"WP	522.20	497.76	474.12	80
30" x 60"	522.20	497.76	474.12	80
30" x 72"	630.92	606.46	577.67	105
36" x 36"	334.26	309.80	295.10	55
42" x 42"	530.68	506.24	482.20	80
42" x 42"CT	554.10	529.66	504.50	80
48" x 48"	601.18	576.74	549.35	95
24" Round	195.28	170.84	162.72	25
30" Round	264.52	240.06	228.67	30
36" Round	346.20	321.76	306.48	45
42" Round	546.00	521.54	496.77	65
48" Round	616.46	592.02	563.90	80
54" Round-seam	773.56	749.12	713.54	110
60" Round-seam	949.32	924.88	880.95	140

	1-4	5-30
36" x 48" Oval	687.68	663.22
36" x 60" Oval	1,215.82	1,191.38

Click here to visit www.NewRetroDining.com or call us anytime at (478) 320-2502

BGA - 125 Gloss Boomerang



BGA - 125

* Backing sheet add 10%

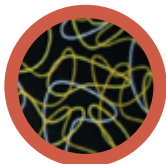

Yellow Ebony



Yellow Glacier

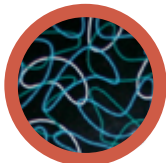

Turquoise Ebony

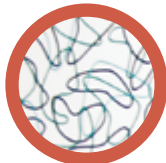

Turquoise Glacier



Ebony



Glacier

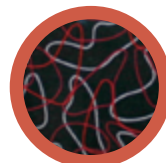

Red Ebony



Red Glacier



Charcoal

BGA - 125 Table Top, 1¼" Bright Grooved Aluminum Edge.
Premium high-gloss Boomerang laminate.

	1 - 4	5 - 30	31+	Lbs.
24" x 24"	179.94	155.50	148.10	30
24" x 22"WP	179.94	155.50	148.10	30
24" x 24"CT	194.74	170.30	162.22	30
24" x 30"	215.90	191.44	182.36	35
24" x 28"WP	215.90	191.44	182.36	35
30" x 22"WP	215.90	191.44	182.36	35
24" x 42"	279.66	255.22	243.10	40
24" x 42"WP	279.66	255.22	243.10	40
24" x 42"CT	294.50	270.06	257.24	40
24" x 46"WP	302.18	277.74	264.55	45
24" x 48"	302.18	277.74	264.55	45
24" x 48"WP	302.18	277.74	264.55	45
30" x 30"	241.76	217.32	206.99	35
30" x 28"WP	241.76	217.32	206.99	40
30" x 42"	312.08	287.64	273.98	55
30" x 42"WP	312.08	287.64	273.98	55
30" x 46"WP	364.84	340.38	324.23	60
30" x 48"	364.84	340.38	324.23	60
30" x 58"WP	498.50	474.06	451.54	80
30" x 60"	498.50	474.06	451.54	80
30" x 72"	602.04	577.60	550.17	105
36" x 36"	319.52	295.06	281.05	55
42" x 42"	506.58	482.14	459.24	80
42" x 42"CT	528.88	504.44	480.48	80
48" x 48"	573.72	549.26	523.18	95
24" Round	187.14	162.70	154.98	25
30" Round	253.08	228.62	217.77	30
36" Round	330.88	306.44	291.89	45
42" Round	521.16	496.72	473.12	65
48" Round	588.28	563.84	537.05	80
54" Round-seam	737.90	713.46	679.57	110
60" Round-seam	905.28	880.84	838.99	140

	1 - 4	5 - 30
36" x 48" Oval	656.08	631.64
36" x 60" Oval	1,159.08	1,134.64

BGA - 225 Table Top



BGA - 225

*Backing sheet add 10%

BGA - 225 Table Top, 2¼" Bright Grooved Aluminum Edge, laminates available in standard Wilsonart & Formica.

	1-4	5-30
36" x 48" Oval	529.40	504.94
36" x 60" Oval	960.54	936.10

	1-4	5-30	31+	Lbs.
24" x 24"	157.96	133.52	127.17	30
24" x 22"WP	157.96	133.52	127.17	30
24" x 24"CT	172.80	148.36	141.31	30
24" x 30"	187.58	163.14	155.40	35
24" x 28"WP	187.58	163.14	155.40	35
30" x 22"WP	187.58	163.14	155.40	35
24" x 42"	236.24	211.78	201.73	40
24" x 42"WP	236.24	211.78	201.73	40
24" x 42"CT	251.10	226.64	215.89	40
24" x 46"WP	248.36	223.92	213.28	45
24" x 48"	248.36	223.92	213.28	45
24" x 48"WP	248.36	223.92	213.28	45
30" x 30"	199.80	175.36	167.04	35
30" x 28"WP	199.80	175.36	167.04	40
30" x 42"	248.36	223.92	213.28	55
30" x 42"WP	248.36	223.92	213.28	55
30" x 46"WP	295.58	271.14	258.26	60
30" x 48"	295.58	271.14	258.26	60
30" x 58"WP	426.40	401.96	382.87	80
30" x 60"	426.40	401.96	382.87	80
30" x 72"	518.18	493.72	470.27	105
36" x 36"	253.78	229.34	218.45	55
42" x 42"	441.24	416.80	397.00	80
42" x 42"CT	463.54	439.10	418.24	80
48" x 48"	489.78	462.65	440.67	95
24" Round	175.52	151.06	143.89	25
30" Round	226.80	202.36	192.74	30
36" Round	284.80	260.36	248.00	45
42" Round	443.92	419.46	399.54	65
48" Round	491.16	466.72	444.55	80
54" Round	777.14	752.70	716.94	110
60" Round	835.12	810.68	772.17	140

BGA - 225 Gloss Cracked Ice



BGA - 225 Cracked Ice

*Backing sheet add 10%

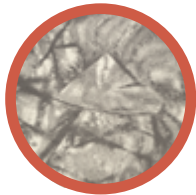

Grey

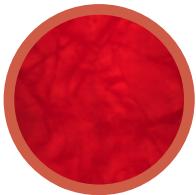

Red



Yellow

BGA - 225 Table Top, 2¼" Bright Grooved Aluminum Edge.

Premium high-gloss Cracked Ice laminate.

	1 - 4	5 - 30	31+	Lbs.
24" x 24"	236.62	212.18	202.10	30
24" x 22"WP	236.62	212.18	202.10	30
24" x 24"CT	252.24	227.80	216.98	30
24" x 30"	285.70	261.26	248.85	35
24" x 28"WP	285.70	261.26	248.85	35
30" x 22"WP	285.70	261.26	248.85	35
24" x 42"	372.82	348.38	331.84	40
24" x 42"WP	372.82	348.38	331.84	40
24" x 42"CT	388.42	363.98	346.69	40
24" x 46"WP	403.58	379.14	361.13	45
24" x 48"	403.58	379.14	361.13	45
24" x 48"WP	403.58	379.14	361.13	45
30" x 30"	321.10	296.66	282.57	35
30" x 28"WP	321.10	296.66	282.57	40
30" x 42"	417.10	392.66	374.00	55
30" x 42"WP	417.10	392.66	374.00	55
30" x 46"WP	489.14	464.68	442.62	60
30" x 48"	489.14	464.68	442.62	60
30" x 58"WP	671.54	647.10	616.35	80
30" x 60"	671.54	647.10	616.35	80
30" x 72"	812.88	788.44	750.98	105
36" x 36"	427.28	402.84	383.71	55
42" x 42"	682.62	658.16	626.90	80
42" x 42"CT	706.02	681.58	649.21	80
48" x 48"	774.20	749.76	714.14	95
24" Round	246.54	222.10	211.55	25
30" Round	336.52	312.08	297.25	30
36" Round	442.76	418.32	398.45	45
42" Round	702.44	678.00	645.79	65
48" Round	794.06	769.60	733.05	80
54" Round-seam	998.36	973.92	927.65	110
60" Round-seam	1,226.76	1,202.32	1,145.21	140

	1 - 4	5 - 30
36" x 48" Oval	886.70	862.26
36" x 60" Oval	1,417.70	1,393.26

BGA - 225 Gloss Boomerang

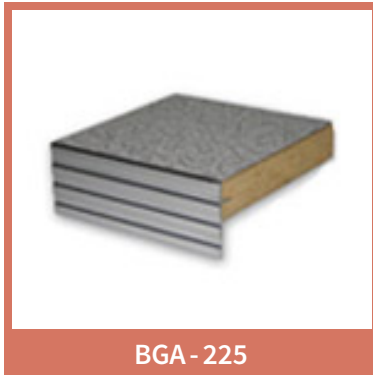

BGA - 225

* Backing sheet add 10%

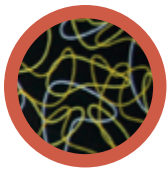

Yellow Ebony



Yellow Glacier

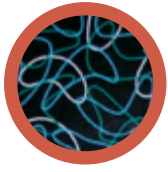

Turquoise Ebony



Turquoise Glacier

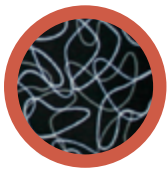

Ebony



Glacier

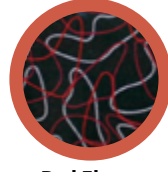

Red Ebony



Red Glacier

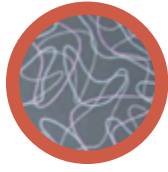

Charcoal

BGA - 225 Table Top, 2¼" Bright Grooved Aluminum Edge.
Premium high-gloss Boomerang laminate.

	1 - 4	5 - 30	31+	Lbs.
24" x 24"	226.52	202.08	192.48	30
24" x 22"WP	226.52	202.08	192.48	30
24" x 24"CT	241.38	216.94	206.64	30
24" x 30"	273.26	248.82	237.01	35
24" x 28"WP	273.26	248.82	237.01	35
30" x 22"WP	273.26	248.82	237.01	35
24" x 42"	356.22	331.78	316.03	40
24" x 42"WP	356.22	331.78	316.03	40
24" x 42"CT	371.10	346.64	330.18	40
24" x 46"WP	385.52	361.06	343.92	45
24" x 48"	385.52	361.06	343.92	45
24" x 48"WP	385.52	361.06	343.92	45
30" x 30"	306.98	282.52	269.10	35
30" x 28"WP	306.98	282.52	269.10	40
30" x 42"	398.40	373.96	356.19	55
30" x 42"WP	398.40	373.96	356.19	55
30" x 46"WP	466.98	442.54	421.52	60
30" x 48"	466.98	442.54	421.52	60
30" x 58"WP	640.74	616.30	587.02	80
30" x 60"	640.74	616.30	587.02	80
30" x 72"	775.32	750.88	715.22	105
36" x 36"	408.10	383.66	365.43	55
42" x 42"	651.28	626.82	597.06	80
42" x 42"CT	673.56	649.12	618.29	80
48" x 48"	738.50	714.04	680.13	95
24" Round	235.96	211.52	201.48	25
30" Round	321.66	297.22	283.11	30
36" Round	422.84	398.40	379.47	45
42" Round	670.14	645.70	615.03	65
48" Round	757.42	732.96	698.15	80
54" Round-seam	951.98	927.54	883.49	110
60" Round-seam	1,169.52	1,145.08	1,090.68	140
	1 - 4	5 - 30		
36" x 48" Oval	845.64	821.18		
36" x 60" Oval	1,351.36	1,326.92		

Click here to visit www.NewRetroDining.com or call us anytime at (478) 320-2502

SE-125 Table Top



SE - 125

**Backing sheet add 10%*

**Radius corners add
\$6.93 each corner**

**For table top longevity
& safety reasons, we
recommend radius
corners on all self-edge
table tops.**

*Add 15% for contrasting
colors on edge*

**SE - 125 Table Top, 1¼" Self Edge, laminates available in
standard Wilsonart & Formica.**

	1 - 4	5 - 30	31+	Lbs.
24" x 24"	118.58	94.14	89.66	30
24" x 22"WP	132.48	108.04	102.92	30
24" x 24"CT	164.68	140.24	133.57	30
24" x 30"	139.48	115.04	109.57	35
24" x 28"WP	153.38	128.94	122.82	35
30" x 22"WP	153.38	128.94	122.82	35
24" x 42"	173.76	149.30	142.22	40
24" x 42"WP	187.66	163.22	155.46	40
24" x 42"CT	228.10	203.64	193.97	40
24" x 46"WP	196.22	171.78	163.61	45
24" x 48"	182.36	157.92	150.38	45
24" x 48"WP	196.22	171.78	163.61	45
30" x 30"	148.14	123.68	117.81	35
30" x 28"WP	162.00	137.54	131.01	40
30" x 42"	182.30	157.86	150.36	55
30" x 42"WP	196.22	171.78	163.61	55
30" x 46"WP	229.54	205.08	195.35	60
30" x 48"	215.62	191.18	182.09	60
30" x 58"WP	321.76	297.32	283.20	80
30" x 60"	307.86	283.40	269.95	80
30" x 72"	372.58	348.14	331.61	105
36" x 36"	186.12	161.68	154.00	55
42" x 42"	318.36	293.92	279.96	80
42" x 42"CT	394.42	369.96	352.40	80
48" x 48"	353.54	329.10	313.47	95
24" Round	130.94	106.50	101.44	25
30" Round	167.10	142.66	135.88	30
36" Round	208.02	183.58	174.86	45
42" Round	320.22	295.78	281.73	65
48" Round	353.54	329.10	313.47	80
54" Round	554.94	530.50	505.30	110
60" Round	596.08	571.64	544.48	140

SE-200 Table Top



SE - 200

* Backing sheet add 10%

Radius corners add
\$6.93 each corner

SE - 300: Custom 3"
self-edge available with
inlays, call for pricing.

Add 15% for contrasting
colors on edge

SE - 200 Table Top, 2" Self Edge, laminates available in standard Wilsonart & Formica.

	1 - 4	5 - 30	31+	Lbs.
24" x 24"	157.96	133.52	127.17	30
24" x 22"WP	171.86	147.42	140.43	30
24" x 24"CT	209.96	185.50	176.69	30
24" x 30"	187.58	163.14	155.40	35
24" x 28"WP	201.48	177.02	168.62	35
30" x 22"WP	201.48	177.02	168.62	35
24" x 42"	236.24	211.78	201.73	40
24" x 42"WP	250.10	225.64	214.93	40
24" x 42"CT	299.94	275.48	262.41	40
24" x 46"WP	262.24	237.80	226.51	45
24" x 48"	248.36	223.92	213.28	45
24" x 48"WP	262.24	237.80	226.50	45
30" x 30"	199.80	175.36	167.04	35
30" x 28"WP	213.72	189.28	180.28	40
30" x 42"	248.36	223.92	213.28	55
30" x 42"WP	262.24	237.80	226.50	55
30" x 46"WP	309.46	285.02	271.48	60
30" x 48"	295.58	271.14	258.26	60
30" x 58"WP	440.32	415.88	396.12	80
30" x 60"	426.40	401.96	382.87	80
30" x 72"	518.18	493.72	470.27	105
36" x 36"	253.78	229.34	218.45	55
42" x 42"	441.24	416.80	397.00	80
42" x 42"CT	535.70	511.26	486.97	80
48" x 48"	491.16	466.72	444.55	95
24" Round	175.52	151.06	143.89	25
30" Round	226.80	202.36	192.74	30
36" Round	284.80	260.36	248.00	45
42" Round	443.92	419.46	399.54	65
48" Round	491.16	466.72	444.55	80
54" Round	777.16	752.72	716.97	110
60" Round	835.12	810.68	772.17	140

Click here to visit www.NewRetroDining.com or call us anytime at (478) 320-2502

Table Bases

We carry a wide variety of table bases. The "H" series base and 884/885 legs are a perfect choice for the classic retro look. "A" "B" "C" "D" series bases represent round tubular, flat, rectangular, and steel designs. Painted black finish is standard for "A" and "B". Bases come in all paint colors. Upcharge for premium paints and powder chrome finish.



"A" series



"B" series



"C" series



"D" series



"H" series



884 & 885 series



1800 TB



"F" series



"G" series

“A” Series Base



“A” series base represents a 2” round tubular design. Painted black finish is standard. Must specify other colors. Chrome is optional.

*Add \$20.76 for 42” high

*Add \$14.67 for wheelchair height

#7 Glide

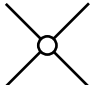
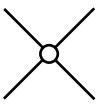
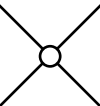
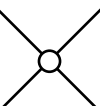
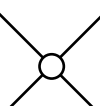
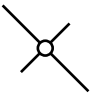
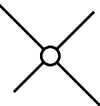
			
A-2x22/2x26			
	1 - 4	5 - 30	31+
	153.40	128.96	123.25
	Add: 32.07 for chrome	Packed Weight: 13 lbs	Two bases required per top
			
A-22x22			
	1 - 4	5 - 30	31+
	155.60	131.16	125.35
	Add: 35.34 for chrome	Packed Weight: 15 lbs	Top Capacity: 24" x 24"
			
A-26x26			
	1 - 4	5 - 30	31+
	158.82	134.38	128.42
	Add: 35.34 for chrome	Packed Weight: 19 lbs	Top Capacity: 30" x 30"
			
A-30x30			
	1 - 4	5 - 30	31+
	161.70	137.26	131.17
	Add: 48.20 for chrome	Packed Weight: 21 lbs	Top Capacity: 36" x 36"
			
A-34x34			
	1 - 4	5 - 30	31+
	164.94	140.48	134.24
	Add: 48.20 for chrome	Packed Weight: 23 lbs	Top Capacity: 42" x 42"
			
A-42x42			
	1 - 4	5 - 30	31+
	171.02	146.58	140.03
	Add: 64.28 for chrome	Packed Weight: 27 lbs	Top Capacity: 54" Round
			
A-22x30			
	1 - 4	5 - 30	31+
	158.78	134.32	128.37
	Add: 48.20 for chrome	Packed Weight: 21 lbs	Top Capacity: 24" x 48"
			
A-26x30			
	1 - 4	5 - 30	31+
	160.34	135.90	129.86
	Add: 48.20 for chrome	Packed Weight: 22 lbs	Top Capacity: 30" x 48"

"B" Series Base



"B" series base, represents standard satin black column with a textured black base bottom.

*Add \$8.88 for chrome column

*Add \$20.76 for 42" high

*Add \$14.67 for wheelchair height

#10 Glide

	1 - 4	5 - 30	31+
	89.68	65.24	62.14
Packed Weight: 20 lbs <i>Two bases required per top</i>			
	1 - 4	5 - 30	31+
	93.52	69.08	65.80
Packed Weight: 22 lbs Top Capacity: 30" x 30" Add: 37.33 for chrome bottom			
	1 - 4	5 - 30	31+
	100.84	76.38	72.77
Packed Weight: 30 lbs Top Capacity: 42" x 42" Add: 37.33 for chrome bottom			
	1 - 4	5 - 30	31+
	100.84	76.38	72.77
Packed Weight: 26 lbs Top Capacity: 30" x 48" Add: 37.33 for chrome bottom			
	1 - 4	5 - 30	31+
	131.08	106.62	101.56
Packed Weight: 34 lbs Top Capacity: 54" x 54"			

Available in all paint colors.

NEW CHROME BOTTOMS

"C" Series Base



"C" series base represents the "Classic" flat steel design. Black bottom with chrome column is standard. Black column available at no extra cost.

*Add \$14.67 for wheelchair height per column

#10 Glide

	1 - 4 5 - 30 31+
	134.76 110.32 105.50
C - 6x22	Packed Weight: 30lbs <i>Two bases required per top</i>
	1 - 4 5 - 30 31+
	162.10 137.66 131.54
C - 18x18	Packed Weight: 40lbs Top Capacity: 36" x 36"
	1 - 4 5 - 30 31+
	162.42 137.98 131.84
C - 16x22	Packed Weight: 45lbs Top Capacity: 30" x 42"
	1 - 4 5 - 30 31+
	180.00 155.54 148.58
C - 22x22	Packed Weight: 48lbs Top Capacity: 42" x 42"
	1 - 4 5 - 30 31+
	180.00 155.54 148.58
C - 18x30	Packed Weight: 50lbs Top Capacity: 36" x 48"
	1 - 4 5 - 30 31+
	245.32 211.98 202.34
C - 22x36	Packed Weight: 85lbs Top Capacity: 42" x 60" * 2 columns
	1 - 4 5 - 30 31+
	302.26 277.82 266.30
C - 30x30	Packed Weight: 95lbs Top Capacity: 48" x 72" * 4 columns

Available in all paint colors.





“C” Series Base



“C” series base represents the “Classic” flat steel design. Black bottom with chrome column is standard. Black column available at no extra cost.

*Add \$14.67 for wheelchair height

#10 Glide

 C-18	1 - 4	5 - 30	31+
	166.44	142.00	135.68
	Packed Weight: 35 lbs Top Capacity: 30" Round		
 C-21	1 - 4	5 - 30	31+
	185.22	160.78	153.56
	Packed Weight: 40 lbs Top Capacity: 36" Round		
 C-24	1 - 4	5 - 30	31+
	198.30	173.86	166.02
	Packed Weight: 50 lbs Top Capacity: 42" Round		
 C-30	1 - 4	5 - 30	31+
	353.06	328.62	313.43
	Packed Weight: 85 lbs Top Capacity: 60" Round		

Available in all paint colors.







“C” Series Base - Bar Height

42" Height

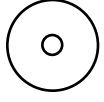

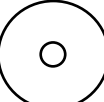
“C” series base represents the “Classic” flat steel design. Black bottom with chrome column is standard. Black column available at no extra cost.

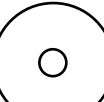
#10 Glide

 C-21-42	1 - 4	5 - 30	31+
	212.29	187.83	179.55
Packed Weight: 55 lbs Top Capacity: 30" Round			
 C-21-42FR	1 - 4	5 - 30	31+
	311.72	287.26	274.78
Packed Weight: 60 lbs Top Capacity: 30" Round Footring			
 C-24-42	1 - 4	5 - 30	31+
	225.39	200.95	192.03
Packed Weight: 65 lbs Top Capacity: 36" Round			
 C-24-42FR	1 - 4	5 - 30	31+
	330.82	306.38	292.99
Packed Weight: 70 lbs Top Capacity: 36" Round Footring			
 C-30-42	1 - 4	5 - 30	31+
	380.11	355.67	339.41
Packed Weight: 95 lbs Top Capacity: 42" Round			
 C-30-42FR	1 - 4	5 - 30	31+
	506.36	481.92	460.18
Packed Weight: 105 lbs Top Capacity: 42" Round Footring			

"D" Series Base



"D" series base, represents a 1" x 2" rectangle tubular steel design standard in black finish also available in all painted finishes, as well as optional chrome.

*Add \$14.67 for wheelchair height

#7 Glide

	1 - 4	5 - 30	31+
	129.64	105.20	100.62
D - 2x22 / 2x26	Add: 32.07 for chrome Packed Weight: 18 lbs		Two bases required
	1 - 4	5 - 30	31+
	131.90	107.46	102.79
D - 22x22	Add: 35.34 for chrome Packed Weight: 20 lbs		Top Capacity: 24" x 24"
	1 - 4	5 - 30	31+
	135.08	110.64	105.81
D - 26x26	Add: 35.34 for chrome Packed Weight: 22 lbs		Top Capacity: 30" x 30"
	1 - 4	5 - 30	31+
	138.10	113.64	108.67
D - 30x30	Add: 48.20 for chrome Packed Weight: 24 lbs		Top Capacity: 36" x 36"
	1 - 4	5 - 30	31+
	141.24	116.80	111.68
D - 34x34	Add: 64.28 for chrome Packed Weight: 26 lbs		Top Capacity: 42" x 42"
	1 - 4	5 - 30	31+
	147.30	122.86	117.45
D - 42x42	Add: 64.28 for chrome Packed Weight: 30 lbs		Top Capacity: 54" Round
	1 - 4	5 - 30	31+
	135.02	110.56	105.74
D - 22x30	Add: 48.20 for chrome Packed Weight: 30 lbs		Top Capacity: 24" x 42"
	1 - 4	5 - 30	31+
	136.58	112.14	107.23
D - 26x30	Add: 48.20 for chrome Packed Weight: 25 lbs		Top Capacity: 30" x 48"

"D" Series Base - Bar Height

42" Height



"D" series base, represents a 1" x 2" rectangle tubular steel design standard in black finish also available in all painted finishes, as well as optional chrome.

*Add \$14.67 for wheelchair height per column

#7 Glide

	<table border="1"> <thead> <tr> <th>1 - 4</th> <th>5 - 30</th> <th>31+</th> </tr> </thead> <tbody> <tr> <td>158.95</td> <td>134.51</td> <td>128.74</td> </tr> <tr> <td>Add: 48.20 for chrome</td> <td>Packed Weight: 27 lbs</td> <td>Top Capacity: 24" Round</td> </tr> </tbody> </table>			1 - 4	5 - 30	31+	158.95	134.51	128.74	Add: 48.20 for chrome	Packed Weight: 27 lbs	Top Capacity: 24" Round	
	1 - 4	5 - 30	31+										
158.95	134.51	128.74											
Add: 48.20 for chrome	Packed Weight: 27 lbs	Top Capacity: 24" Round											
D - 22x22 - 42													
	<table border="1"> <thead> <tr> <th>1 - 4</th> <th>5 - 30</th> <th>31+</th> </tr> </thead> <tbody> <tr> <td>258.76</td> <td>234.32</td> <td>224.35</td> </tr> <tr> <td>Add: 48.20 for chrome</td> <td>Packed Weight: 30 lbs</td> <td>Top Capacity: 24" Round</td> </tr> </tbody> </table>			1 - 4	5 - 30	31+	258.76	234.32	224.35	Add: 48.20 for chrome	Packed Weight: 30 lbs	Top Capacity: 24" Round	*Footring
	1 - 4	5 - 30	31+										
258.76	234.32	224.35											
Add: 48.20 for chrome	Packed Weight: 30 lbs	Top Capacity: 24" Round											
D - 22x22 - 42FR													
	<table border="1"> <thead> <tr> <th>1 - 4</th> <th>5 - 30</th> <th>31+</th> </tr> </thead> <tbody> <tr> <td>166.27</td> <td>141.83</td> <td>135.73</td> </tr> <tr> <td>Add: 48.20 for chrome</td> <td>Packed Weight: 32 lbs</td> <td>Top Capacity: 30" / 36" Round</td> </tr> </tbody> </table>			1 - 4	5 - 30	31+	166.27	141.83	135.73	Add: 48.20 for chrome	Packed Weight: 32 lbs	Top Capacity: 30" / 36" Round	
	1 - 4	5 - 30	31+										
166.27	141.83	135.73											
Add: 48.20 for chrome	Packed Weight: 32 lbs	Top Capacity: 30" / 36" Round											
D - 30x30 - 42													
	<table border="1"> <thead> <tr> <th>1 - 4</th> <th>5 - 30</th> <th>31+</th> </tr> </thead> <tbody> <tr> <td>306.40</td> <td>281.96</td> <td>269.73</td> </tr> <tr> <td>Add: 48.20 for chrome</td> <td>Packed Weight: 35 lbs</td> <td>Top Capacity: 30" / 36" Round</td> </tr> </tbody> </table>			1 - 4	5 - 30	31+	306.40	281.96	269.73	Add: 48.20 for chrome	Packed Weight: 35 lbs	Top Capacity: 30" / 36" Round	*Footring
	1 - 4	5 - 30	31+										
306.40	281.96	269.73											
Add: 48.20 for chrome	Packed Weight: 35 lbs	Top Capacity: 30" / 36" Round											
D - 30x30 - 42FR													
	<table border="1"> <thead> <tr> <th>1 - 4</th> <th>5 - 30</th> <th>31+</th> </tr> </thead> <tbody> <tr> <td>168.31</td> <td>143.87</td> <td>137.66</td> </tr> <tr> <td>Add: 64.28 for chrome</td> <td>Packed Weight: 34 lbs</td> <td>Top Capacity: 42" Round</td> </tr> </tbody> </table>			1 - 4	5 - 30	31+	168.31	143.87	137.66	Add: 64.28 for chrome	Packed Weight: 34 lbs	Top Capacity: 42" Round	
	1 - 4	5 - 30	31+										
168.31	143.87	137.66											
Add: 64.28 for chrome	Packed Weight: 34 lbs	Top Capacity: 42" Round											
D - 34x34 - 42													
	<table border="1"> <thead> <tr> <th>1 - 4</th> <th>5 - 30</th> <th>31+</th> </tr> </thead> <tbody> <tr> <td>314.88</td> <td>290.44</td> <td>277.81</td> </tr> <tr> <td>Add: 64.28 for chrome</td> <td>Packed Weight: 36 lbs</td> <td>Top Capacity: 42" Round</td> </tr> </tbody> </table>			1 - 4	5 - 30	31+	314.88	290.44	277.81	Add: 64.28 for chrome	Packed Weight: 36 lbs	Top Capacity: 42" Round	*Footring
	1 - 4	5 - 30	31+										
314.88	290.44	277.81											
Add: 64.28 for chrome	Packed Weight: 36 lbs	Top Capacity: 42" Round											
D - 34x34 - 42FR													

Flip - Top Table

Not Sold Separately



The Flip - Top Booth & Table Attachment System was invented for 2 purposes, cleanliness and an economical way to suspend a table top without the expense of special construction required within the walls of the restaurant. Standard finish is satin black powder coat

Model FT - 44:

accommodates 44", as well as 48"L booths

337.33

Any qty. Maximum Table Width: 30"

Model FT - 60:

accommodates booths up to 60"L

371.55

Any qty. Maximum Table Width: 30"

Model FT - 30:

accommodates both 24" & 30"L deuce booths. This model offers the cantilever effect only, but does not flip up.

312.91

Any qty. Maximum Table Width: 30"



Special Note: When ordering this product, please specify the booths and table tops that are to accompany this purchase. Also, please be aware that the table tops will not be pre - drilled, in order for you or your customer to adjust the distance the top will be from the wall. We recommend the top to be approximately ¼" from the wall.

The Flip - Top and booth must be ordered together.

“F” Series Cantilever

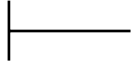

The “F” series cantilever style base utilizes 2” square heavy wall 14 gauge construction with angle support. Black painted finish.

 F-21-WL	1 - 4	5 - 30	31+
	127.02	102.56	97.70
	Packed Weight: 16 lbs Top Capacity: 24" - 30"		
 F-29-WL	1 - 4	5 - 30	31+
	133.52	109.08	103.90
	Packed Weight: 18 lbs Top Capacity: 36" - 48"		
 F-47-WL	1 - 4	5 - 30	31+
	142.10	117.66	112.07
	Packed Weight: 25 lbs Top Capacity: 54" - 60"		

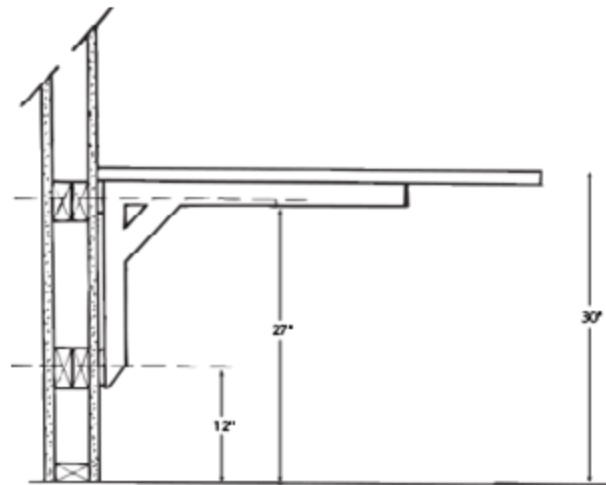

*We recommend wall blocking at 12" and 27"
to secure the cantilever.*

“G” Series Cantilever



The “G” series cantilever, utilizes 2” square heavy wall construction and includes table mounting bracket. Black painted finish.

Painted

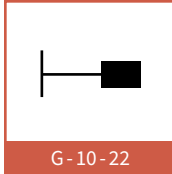

	1 - 4	5 - 30	31+
	82.18	57.74	55.00
Packed Weight: 10 lbs		Top Capacity: 24"-30"	

Painted

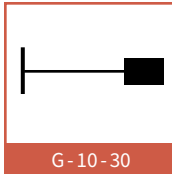

	1 - 4	5 - 30	31+
	89.54	65.10	62.01
Packed Weight: 12 lbs		Top Capacity: 36"-54"	

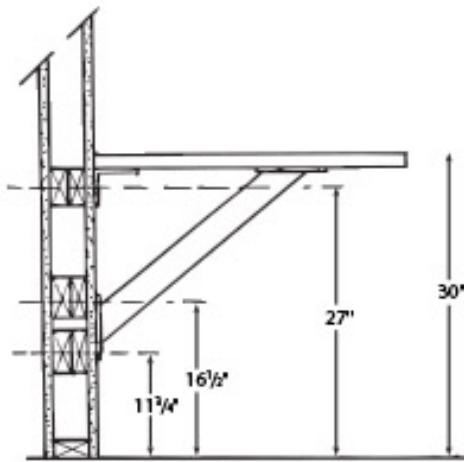

G - 10 - 22

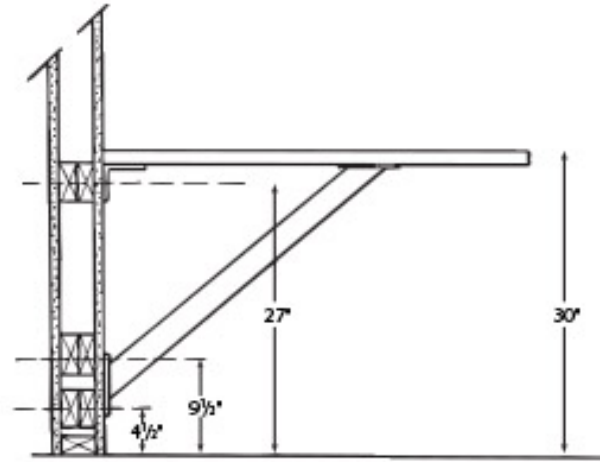

G - 10 - 30

“H” Series Base



“H” Series

The “H” series fountain style base is a bolt down design utilizing a 3½" column diameter. Painted or standard chrome is the same price.

*10" x 10" Table Spider, see page 94 for floor attachments

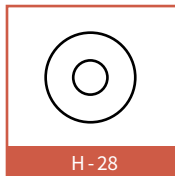

H - 28

1 - 4	5 - 30	31+
171.18	146.74	140.25
Packed Weight: 14lbs Top Capacity: 30" *Table Height		

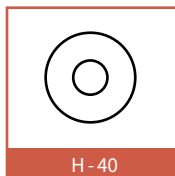

H - 40

1 - 4	5 - 30	31+
216.47	192.01	183.53
Packed Weight: 20lbs Top Capacity: 24" *Bar Height		

42" Bar Height



“H” Teardrop

The “H” series fountain style base is a bolt down design utilizing a 3½" column diameter. Featuring our “Teardrop” design. See “Teardrop brochure” for available colors.

*Standard in chrome

*Teardrop standard colors are red and black. Upcharge for white, blue, yellow, and pink priced at \$19.53; Minimum of 7 is required.

*Shown w/ optional grooved column



H - 28 - TD

1 - 4	5 - 30	31+
210.70	186.26	177.89
Packed Weight: 14lbs Top Capacity: 30" *Table Height		



H - 40 - TD

1 - 4	5 - 30	31+
256.01	231.57	221.21
Packed Weight: 20lbs Top Capacity: 24" *Bar Height		

42" Bar Height

1800 Series Base



1800 Series

"1800" series fountain style base, is a bolt - down design utilizing a 3" square column. Painted only.

*Type B & C attachments only

*10" x 10" table spider

Table Height



1800 - TB - 28

	1 - 4	5 - 30	31+
	197.69	173.25	166.76
30" Table Height Base	Packed Weight: 27 lbs	Top Capacity: 30"	

Bar Height



1800 - TB - 40

	1 - 4	5 - 30	31+
	239.81	215.35	206.87
42" Bar Height Base	Packed Weight: 40 lbs	Top Capacity: 24"	

Available in paint



884 Classic Legs

884 set of 4 *Classic Table Legs, 16 gauge, 1½" diameter tubular steel, chrome finish*

	1 - 4	5 - 30	31+
	225.82	201.38	192.96
884 singles <i>Single leg with wall angle bracket</i>			#17 Glide
	1 - 4	5 - 30	31+
	105.59	81.15	77.57
Add: \$40.33 for pre - drill	Packed Weight: 12 lbs	Dimensions: 28¾"H	

Available in paint



885 Classic Legs

885 set of 4 *Classic Table Legs, 16 gauge, 1" diameter tubular steel, chrome finish*

	1 - 4	5 - 30	31+
	225.82	201.38	192.96
885 singles <i>Single leg with wall angle bracket</i>			#16 Glide
	1 - 4	5 - 30	31+
	105.59	81.15	77.57
Add: \$40.33 for pre - drill	Packed Weight: 12 lbs	Dimensions: 28¾"H	



ACCESSORIES



Accessories



Chair Caddy, is a 2 piece design permits shipping by UPS, 8 chair capacity.

Weight: 28 lbs

Replacement Wheels: \$34.34 each

214.38

*For model X-43, use code CDD-43

*Spectrum series stacks 6 high



Chair Dolly, single model has 10 chair capacity, while the double model has a 20 chair capacity.

Weight: 10 lbs single / 20lbs double

131.41 Single

170.14 Double

*For model X-43, use code DOL-43

*Not to be used with Spectrum Series chairs



Standard panels are constructed from 3/4" plywood and are 36" high, specify length as 66", 69", or 72".

*Add 15% for 42" height

*Add 30% for 48" height

Decorative Wall Panels

Laminated 1 side	474.46
Laminated 2 sides	715.50
Smooth upholstered 1 side	283.73
Smooth upholstered 2 sides	437.12
Channel or Diamond Tufted 1 side	589.90
Channel or Diamond Tufted 2 side	798.28

Add per panel to accommodate cantilever tables.

103.74

Accessories



Hall Costumer - Chrome only with 15" round black plate steel base

211.66

Weight: 25 lbs

Dimensions: 60"H

Replacement Hooks: \$22.62



Booth Costumer - Chrome only

148.17 #56 two hook style

177.87 #57 three hook style

Weight: 7 lbs

Dimensions: 60"H

Replacement Hooks: \$22.62



Custom Etched Acrylic Gallery

Call (478) 320-2502 for pricing

* Pricing varies based on design

* Gallery posts standard in powder chrome

Enjoy
Coca-Cola



COCA-COLA

NewRetroDining.com

Made in USA - Retro 50's Furniture

Coca-Cola Series



Coke "Dynamic Ribbon" Booth CK - 1

Features

44" W x 36" H

"Coke Red" and "Coke White"

Optional:

*Etched "Coke Red Disc Icon Acrylic Gallery"
(Powder chrome mounting posts included)

*Add \$296.42 for optional gallery

Quantity

Each	852.83
------	--------

Items Per Carton: 1

Packed Size: 24" x 46" x 37"

*Call (478) 320-2502 for double booth pricing

Weight: 140 lb

Shipping Class: 85



215 - 125R CBB

Features

30" H x 15" W x 15" D

Upholstered Seat Ring

Bull's - Eye Seat

16 Gauge

Quantity

50+	203.96
-----	--------

1 - 49	233.15
--------	--------

Items Per Carton: 1

Packed Size: 17" x 17" x 31"

Weight: 25 lb

Shipping Class: 150



215 - 782 FT

Features

30" H x 15" W x 15" D

Black Striped Seat Ring

Black "Fishtail Seat"

16 Gauge

Quantity

50+	199.39
-----	--------

1 - 49	228.54
--------	--------

Items Per Carton: 1

Packed Size: 17" x 17" x 31"

Weight: 25 lb

Shipping Class: 150



250 - 781 CBB

Features

30" H x 16" W x 16" D

Bull's - Eye Seat

Red Painted Seat Ring

Black Accent Piping

Quantity

50+	316.28
-----	--------

1 - 49	343.71
--------	--------

Items Per Carton: 1

Packed Size: 17" x 17" x 31"

Weight: 25 lb

Shipping Class: 150



250 - 921 CBB

Features

30" H x 16" W x 16" D
 30" Seat Height
 Chrome Stool with Back
 Bull's - Eye Back

Quantity

50+	387.75
1 - 49	415.20

Items Per Carton: 1 Weight: 30 lb
 Packed Size: 17" x 19" x 33" Shipping Class: 150



264 - 125 CBB

Features

30" H x 16" W x 16" D
 Upholstered Seat Ring
 White Accent Piping
 Bull's - Eye Seat

Optional:

24" Seat Height at No Cost

Quantity

50+	241.39
1 - 49	268.82

Items Per Carton: 1 Weight: 25 lb
 Packed Size: 17" x 17" x 31" Shipping Class: 150



264 - 782 FT

Features

30" H x 16" W x 16" D
 Black Grooved Seat Ring
 Black "Fishtail Seat"
 Red Stripes

Optional:

24" Seat Height at No Cost

Quantity

50+	239.08
1 - 49	267.62

Items Per Carton: 1 Weight: 25 lb
 Packed Size: 17" x 17" x 31" Shipping Class: 150



264 - 782 RB CBB

Features

30" H x 16" W x 16" D
 30" Seat Height
 Bull's - Eye Back
 Back with Red Striping

Optional:

24" Seat Height at No Cost

Quantity

50+	352.74
1 - 49	381.88

Items Per Carton: 1 Weight: 30 lb
 Packed Size: 17" x 19" x 33" Shipping Class: 150



300 - 921 CBB

Features

30" H x 16" W x 16" D
 30" Seat Height
 White Accent Piping
 Bull's - Eye Back

Optional:

24" Seat Height at No Cost

Quantity

50+	367.67
1 - 49	395.12

Items Per Carton: 1
 Packed Size: 17" x 19" x 33"

Weight: 30lb
 Shipping Class: 150



400 - 46 FT

Features

30" H x 16" W x 16" D
 Black Painted Seat Ring
 Red Accent Piping
 Black "Fishtail Seat"

Quantity

50+	256.88
1 - 49	284.32

Items Per Carton: 1
 Packed Size: 17" x 17" x 31"

Weight: 25lb
 Shipping Class: 150



400 - 49 NS CBB

Features

30" H x 16" W x 16" D
 Scalloped Chrome Seat Ring
 Bull's - Eye Seat
 White Accent Piping

Quantity

50+	269.21
1 - 49	296.63

Items Per Carton: 1
 Packed Size: 17" x 17" x 31"

Weight: 25lb
 Shipping Class: 150



500 - 782 CBB

Features

30" H x 16" W x 16" D
 Grooved Seat Ring
 Red & Black Striped Seat Ring
 Bull's - Eye Seat

Optional:

24" Seat Height at No Cost

Quantity

50+	337.95
1 - 49	365.39

Items Per Carton: 1
 Packed Size: 19" x 19" x 31"

Weight: 35lb
 Shipping Class: 150

Footrest Is Not Available On 18" Seat Height



752 CBB

Features

30" H x 16" W x 16" D
 1³/₁₆" Sq. Steel Tubing (16 Gauge)
 #2 Glide
 Bull's - Eye Seat
 White Accent Piping
 Standard Chrome

Optional:

24" Seat Height at No Cost

Quantity

50+	194.67
1 - 49	200.00

Items Per Carton: 1

Weight: 16 lb

Packed Size: 17" x 17" x 30"

Shipping Class: 150



1500 - 49 NS FT - 505

Features

30" H x 15" W x 15" D
 Scalloped Chrome Seat Ring
 Fountain Stool with 505 Footrest
 Black "Fishtail Seat"
 Red Accent Piping

Optional:

Footrest (Shown with 505)
 18" 24" Seat Height at No Cost

Quantity

* Priced with optional 505 footrest

50+	411.80
1 - 49	439.35

Items Per Carton: 1

Weight: 20 lb

Packed Size: 15" x 15" x 30"

Shipping Class: Head - 85
 Base - 70



1700 - 782 CBB

Features

30" H x 15" W x 15" D
 Fountain Stool With Teardrop
 Red Stripes
 Bull's - Eye Seat

Optional:

24" Seat Height at No Cost

Quantity

50+	354.89
1 - 49	382.34

Items Per Carton: 1

Weight: 20 lb

Packed Size: 15" x 15" x 30"

Shipping Class: Head - 85
 Base - 70



1800 - X50 CWD

Features

30" H x 15" W x 15" D
 Old Style Cast Iron Coppervein Base
 Natural Wood Seat
 Vintage Logo

Optional:

24" Seat Height at No Cost

Quantity

50+	388.67
1 - 49	416.10

Items Per Carton: 1

Weight: 30 lb

Packed Size: 15" x 15" x 30"

Shipping Class: Head - 85
 Base - 70

Available Coke Designs



CBB

Bull's - Eye



FT

Black "Fishtail Seat"



Vintage Logo

Vintage Seat"



1800 - X50 CWD - 606

Features

30" H x 15" W x 15" D
Old Style Cast Iron Textured Black Base
Walnut Wood Seat
Vintage Logo

Optional:

Footrest (*Shown with 606*)
24" Seat Height at No Cost

Quantity

**Priced with optional 606 footrest*

50+	489.58
1 - 49	517.03

Items Per Carton: 1

Weight: 32 lb

Packed Size: 15" x 15" x 30"

Shipping Class: Head - 85
Base - 70



Coke Diner Set

Features

36" x 48" Oval Top
Grooved Aluminum Edge
Red Glacier Boomerang Laminate
Set of 885 Chrome Legs &
(4) "921 CBB" Chairs

Set	1,936.99
-----	----------

Items Per Carton: Varies

Weight: (Top) 80 lb

Packed Size: (Top) 38" x 50" x 5"

(Base) 19 lb

(Base) 10" x 10" x 34"

(Chair) 36 lb

(Chairs) 40" x 26" x 19"

Shipping Class: Head - 85

Base - 70

Chair - 150



921 CBB

Features

Chrome 18" Seat Height
Bull's - Eye Back
1" Pulled Seat
#6 Platform Glide

Quantity

50+	205.01
1 - 49	219.18

Items Per Carton: 2

Weight: 20 lb (2 chairs/carton)

Packed Size: 40" x 26" x 19"

Shipping Class: 150



BGA 125 - 30 CBB

Features

30" Round Top/30" Height
Grooved Aluminum Edge
Includes Textured Black Base
w/ Chrome Column

* Shown with Optional 921 CBB

Quantity

50+	378.64
1 - 49	393.45

Items Per Carton: Varies

Weight: (Top) 30 lb

Packed Size: (Top) 32" x 32" x 2"
(Base) 17" x 6" x 23"

(Base) 22 lb

Shipping Class: 70



BGA 125 - 30 - 42 CBB

Features

30" Round Top/42" Height
Grooved Aluminum Edge
Includes Textured Black Base w/
Chrome Column

* Shown with Optional 215 - 125R CBB

Quantity

50+	427.45
1 - 49	457.06

Items Per Carton: Varies

Weight: (Top) 30 lb

Packed Size: (Top) 32" x 32" x 2"
(Base) 22" x 5" x 35"

(Base) 30 lb

Shipping Class: 70



BGA 125 - 2442 CBB

Features

24" x 42" Rectangle Top
30" Height (For Chairs & Booths)
Grooved Aluminum Edge
Includes Textured Black Base
w/ Chrome Column

Quantity

Each	452.61
------	--------

Items Per Carton: Varies

Weight: (Top) 40 lb

Packed Size: (Top) 26" x 44" x 2"
(Base) 23" x 7" x 23"

(Base) 26 lb

Shipping Class: 70



OUTDOOR



See Catalog For Available Umbrella Colors



6' Umbrella

533.23



7' Umbrella

533.23



Round Umbrella Base

188.58



Square Umbrella Base

228.38

** No Quantity Discounts*

Platinum and Black finishes available for Barkley Series and Micromesh Tops.

Barkley



BRK - 100

146.28



BRK - 100 AR

154.56



BRK - 1100 BS

198.72

Minimum of 4 for Chairs (Buy in multiples of 4 only)
Minimum of 2 for Barstool (Buy in multiples of 2 only)

Micromesh Tops & Base Combo Sets



Diner Height
w/ Butterfly Base



Pub Height
w/ Spun Base

Mesh Top Sizes	Butterfly Base	Spun Base	Butterfly Base Lbs.	Spun Base Lbs.
24" x 30"	339.49	593.40	35	64
24" x 30" (42" Height)	N/A	819.72	-	77
30" x 40"	391.93	N/A	45	-
30" x 30"	353.29	607.20	35	64
30" x 30" (42" Height)	N/A	833.53	-	77
36" x 36"	391.93	662.41	41	70
36" x 36" (42" Height)	N/A	676.20	-	83
30" Round	353.29	607.20	35	64
30" Round (42" Height)	N/A	676.20	-	77
36" Round	391.93	662.40	41	70
36" Round (42" Height)	N/A	833.52	-	83
42" Round	419.53	690.00	47	89
42" Round (42" Height)	N/A	703.80	-	89

* Butterfly base not available at 42" height

FIFTIES

STOCKING PROGRAM

Limited Quantities - Subject to Availability

	IN STOCK	MIN. ORDER	PRICE
 <p>921 "V" Chrome <i>Zodiac Burgandy w/ Silver "V"</i></p>	60 each	2	159.81 (50+) 163.84 (11-49) 190.81 (1-10)
 <p>V - 4300 Vintage Single Booth 36" Height x 44" Long <i>Zodiac Burgandy w/ Silver "V"</i></p>	15 each	1	842.25
 <p>752 Econo Stool 30" Height (<i>Chrome</i>) <i>Zodiac Burgandy</i> (<i>Striping not available</i>)</p>	20 each	1	163.07
 <p>BGA - 125 Bright Grooved Aluminum Table Top 30" x 42" Laminate: Red Glacier Boomerang</p>	15 each	1	329.61
 <p>885 Chrome Classic Style Legs</p>	15 sets	1 set	246.86
 <p>B - 22 x 30 Chrome Column</p>	15 each	1	130.51

* Stocking Program Items cannot be combined with standard production orders.

SEATING GUIDELINES

General guides for space planning and determining furniture needs

Space Planning:

In preliminary space planning, the “Rule of Thumb” for determining the area requirements for a restaurant is: Dining Room: 60% of total area. Kitchen, Cooking, Storage, Preparation, etc.: 40% of total area.

When originating space requirements, anticipate that Banquet seating may use as little as 10 square feet per person. A good average for restaurants or coffee shops with general menus is about 12 square feet per person. This will provide for traffic aisles, wait stations, etc.

Example: A 200 seat restaurant will require 2,400 square feet of dining area. Since this would be 60% of the total area, the total area would be 4000 square feet.

When the area available has already been established (i.e. an existing building being remodeled as a restaurant), the “Rule of Thumb” is used as follows.

Example: A space of 2800 square feet is available. 60% **Dining Area:** 1680 square feet (140 seats); 40% **Kitchen Area:** 1120 square feet. Details will be determined after

floor plans are prepared and owner’s ideas are considered and incorporated into the plans. Suggested square feet per person for different restaurant types:

Commercial Cafe: 16 - 18 square feet

Industrial Cafe: 12 - 15 square feet

Counter Service: 18 - 20 square feet

Table Service (minimum): 11 - 14 square feet

Table Service, Hotel/Club: 15 - 18 square feet

Banquet (minimum): 10 - 11 square feet

The traffic path between occupied chairs would be at least 18 inches wide. Leave 4 - 5 feet between tables (This figure includes chair space). To determine area for wait stations: 1 small station (6 - 10 square feet) per 20 diners. 1 large central station (25 - 40 square feet) per 60 diners. In determining the length for a bar, allow 1’8” - 1’10” per person (standup) or 2’ per bar stool.

Furniture Guidelines:

Table Height: 29” - 30” **Bar Height:** 42” - 45”

Seat Height: 17” - 18” **Bar Stool Height:** 28” - 30”

Bar Dimensions

A. Outer bar edge to wall.....	76” - 84”
B. Outer bar edge back wall.....	82” - 104”
C. Outer bar edge to drinking shelf.....	66” - 72”
D. Outer bar edge to equipment edge.....	23” - 28”
E. Behind bar traffic area.....	30” - 36”
F. Back bar depth.....	24” - 30”
G. Drinking shelf depth.....	10” - 12”
H. Drinking shelf customer area.....	18”
J. Customer traffic area.....	30”
K. Bar seating area.....	18” - 24”
L. Bar depth.....	18” - 24”
M. Footstep depth.....	6” - 9”
N. Footstep height.....	7” - 9”
O. Room divider screen (high)	76”
P. Room divider screen (low)	55”
Q. Drinking shelf height	42” - 45”
R. Top of barstool to bottom of bar.....	11” - 12”
S. Depth of behind-bar equipment.....	22” - 26”
T. Behind-bar equipment height.....	30”
U. Bar height.....	42” - 45”
V. Back bar height.....	36” - 42”
W. Back wall shelf height.....	60” - 69”



SEATING GUIDELINES

FIXED SEATING DIMENSIONS

Bar Counter Dimensions

- A. Customer seating area.....12" - 18"
- B. Counter depth.....18" - 24"
- C. Service traffic area.....36"
- D. Seat height.....30" - 31"
- E. Footstep height.....12"
- F. Depth of counter underside.....10"
- G. Top of seat to underside of counter..11" - 12"
- H. Counter height.....42"
- J. Back service counter height.....36"

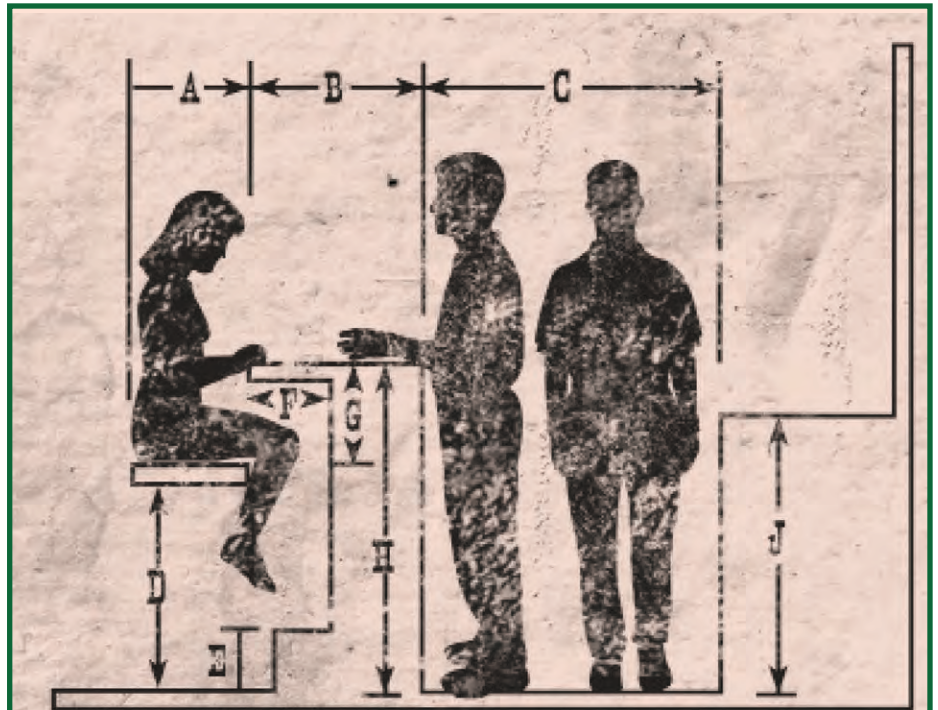

Booth Dimensions

- A. Total booth width.....64" - 74"
- B. Seat back depth.....3" - 6"
- C. Seat back-to-table edge clearance.....16"
- D. Table width.....24" - 42"
- E. Table edge to back of seat cushion... 19" - 22"
- F. Table top height.....29" - 30"
- G. Top of seat to underside of counter..16" - 18"

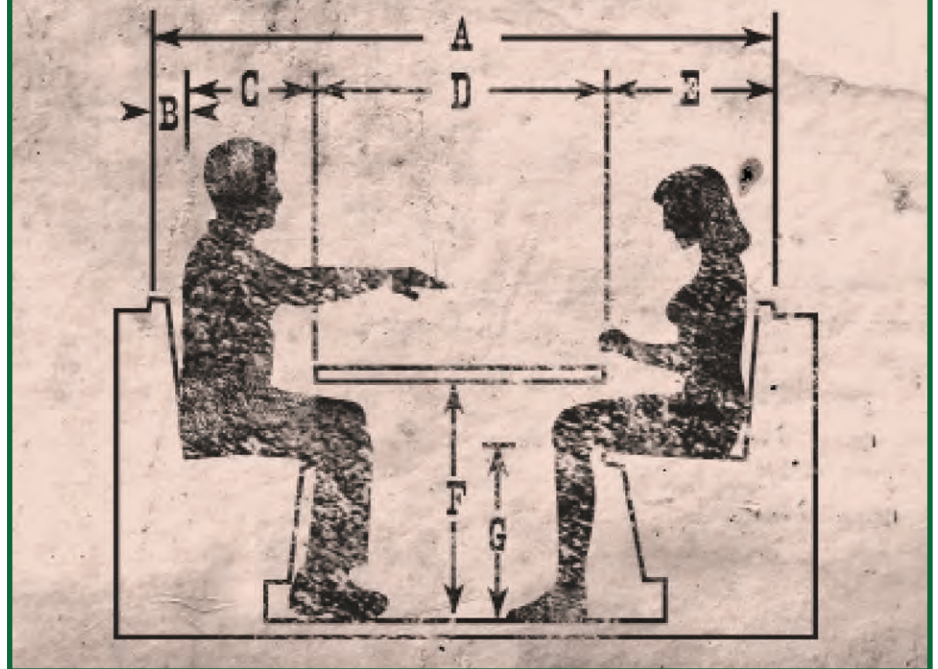

ADA GUIDELINES

TABLE SEATING DIMENSIONS



Table Dimensions

- A. Total area required for table.....60"- 90"
- B. Table top width.....24"- 42"
- C. Customer traffic & seating area.....54"- 72"
- D. Customer seating area.....18"- 24"
- E. Traffic area.....18"- 24"
- F. Table top height.....29"- 30"
- G. Seat height.....16"- 18"

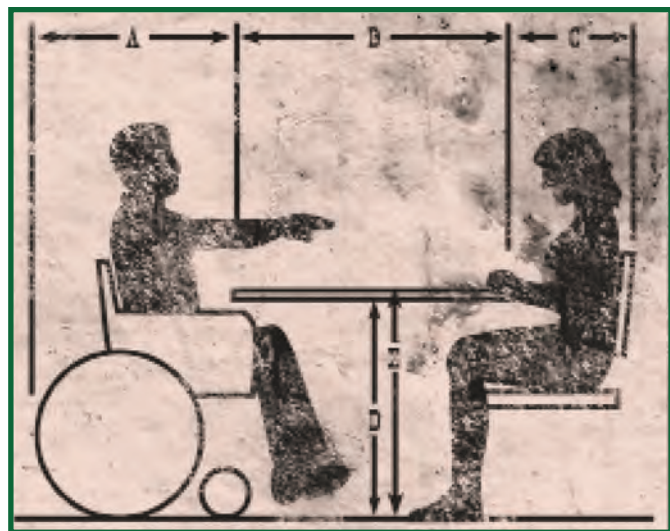

Wheelchair Requirements

- A. Wheelchair seating area.....30"
- B. Table top width.....24"- 42"
- C. Customer seating area.....18"- 24"
- D. Distance to underside of table.....30"
- E. Table top height.....31"

CONTACTING ARTISTA GALLERY, INC.

NewRetroDining.com, NewRetroDesign.com, NewRetroCars.com

If you have any questions about this Terms and Conditions statement, please contact:

Artista Gallery, Inc.

1004 Briarcliff Rd.

Warner Robins, GA 31088

Ph: (478) 320-2502

Fax: (404) 420-2890

Legal@NewRetroDining.com

